



**GMP**<sup>TM</sup>

MediTech

*Innovation for life...*



# TRAUMA

A full Range of Product for TRAUMA SYSTEM





**GMP**<sup>™</sup>  
MediTech  
*Innovation for life...*



GMP MediTech is a prominent orthopedic implant manufacturer based in Ahmedabad, India, with a global presence since 2021. We are dedicated to delivering exceptional orthopedic solutions that adhere to rigorous global standards, all under the esteemed brand name "GMP MediTech."

Our primary focus is on providing top-quality, customized orthopedic solutions that prioritize patient affordability. We understand the importance of affordable healthcare and strive to make a positive impact.

At the heart of our operations is a team of highly trained and professional sales associates available 24/7 to provide unwavering support to our valued customers. Our journey began in 2021, and we have since specialized in the manufacturing of various medical devices, including a comprehensive range of orthopedic implants such as Locking Plates, Locking Screw, Mini Fragment, Pelvic System, Variable angle Locking System, Intramedullary Nails, Spinal System, External Fixator, Arthroscopy System & Surgical Instruments. These products are instrumental in the treatment, fixation, and healing of different types of human bone fractures.

What sets us apart is our commitment to innovation and excellence. We have embraced cutting-edge technology with robotic-controlled CNC machinery and a highly skilled workforce. Our state-of-the-art manufacturing facility in India is considered one of the largest and most sophisticated in the world. Our manufacturing process and production management systems hold prestigious certifications, including ISO 13485:2016 and Indian FDCA, reflecting our unwavering dedication to quality and safety.

Our corporate vision is to become a leading developer of innovative, high-quality orthopedic solutions that remain accessible to all. This vision underscores our commitment to the well-being of patients and our aspiration to lead the industry in innovation and affordability.

One of our notable achievements is in the realm of locking plate systems, which offer distinct advantages in the osteosynthesis of mandibular fractures. Unlike conventional plate and screw systems, our locking plates and screw systems simplify the surgical process, promoting greater stability and reducing the risk of inflammatory complications.

In essence, GMP MediTech is not just a manufacturer; we are a healthcare partner committed to revolutionizing orthopedic solutions, improving patient outcomes, and setting new standards in the industry.



# CONTENTS

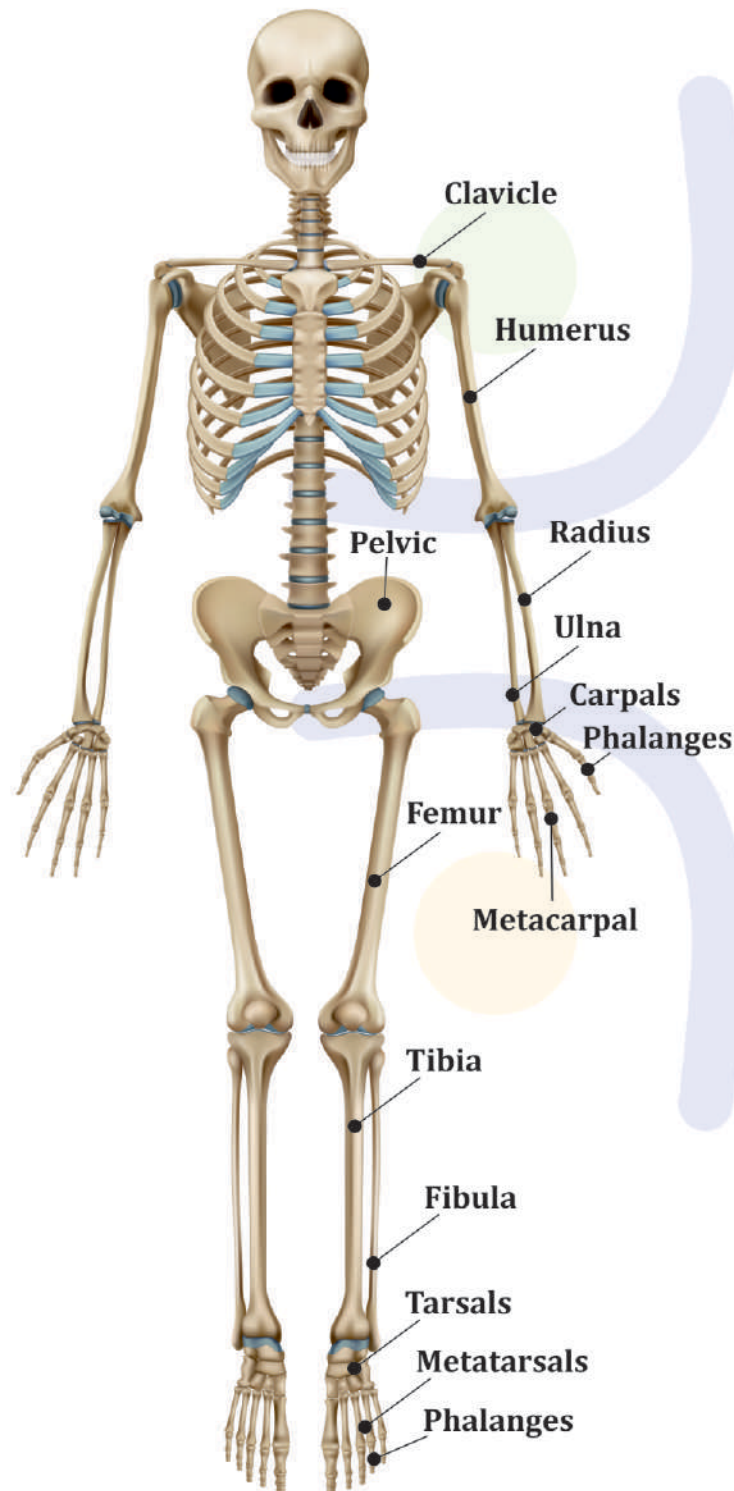

## Mini Fragment System

1.5mm Mini Fragment System .....	(2)
2.0mm Mini Fragment System .....	(3)
2.4mm Mini Fragment System .....	(4)
2.7mm Mini Fragment System .....	(5)
Mini Fragment Instrument Set .....	(6)

## Locking Plate System

Clavicle System .....	(8)
Humeral System .....	(8)
Elbow System .....	(9)
Radius System .....	(10)
Variable Angle System .....	(11)
Tibia System .....	(12)
Tomofix System .....	(13)
Femur System .....	(13)
Fibula System .....	(14)
Foot System .....	(14)

## Non-Locking Plate System

Non-Locking Plate .....	(16)
Screw .....	(17)

## Pelvic System

Pelvic System .....	(21)
Screw & Instrument Set .....	(22)

## Instrument Set

(23)

## Interlocking Nail System

PFNA-II System .....	(32)
TFN/PFN System .....	(33)
Expert Tibia Nail System .....	(34)
Expert Femur Nail System .....	(35)
I.L Tibia/Femur System .....	(36)
Humerus Nail System .....	(37)
Supra Condylar System .....	(38)
Elastic Nail System .....	(39)

## Certificates

(40)



**GMP™**

MediTech

*Innovation for life...*

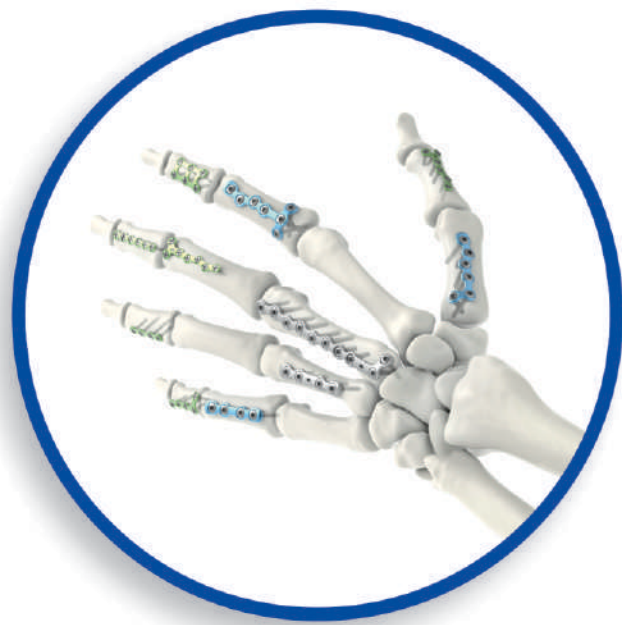

# MINI FRAGMENT

A full Range of Product  
for **MINI FRAGMENT**





## 1.5 MM LCP STRUT PLATE



**PRODUCT CODE :** GMP521  
**HOLE :** 08  
**DIRECTION :** RIGHT / LEFT

## 1.5 MM LCP ROTATION CORRECTION PLATE



**PRODUCT CODE :** GMP523  
**HOLE :** 04, 05, 06

## 1.5 MM LCP CONDYLAR PLATE



**PRODUCT CODE :** GMP529  
**HOLE :** 03, 04, 05, 06, 07, 08

## 1.5 MM LCP T-PLATE 2 HEAD HOLE



**PRODUCT CODE :** GMP537  
**HOLE :** 03, 04, 05, 06, 07, 08

## 1.5 MM LCP T-PLATE 3 HEAD HOLE



**PRODUCT CODE :** GMP549  
**HOLE :** 03, 04, 05, 06, 07, 08

## 1.5 MM LCP T-PLATE 4 HEAD HOLE



**PRODUCT CODE :** GMP550  
**HOLE :** 03, 04, 05, 06, 07, 08

## 1.5 MM LCP Y-PLATE 3 HEAD HOLE



**PRODUCT CODE :** GMP542  
**HOLE :** 03, 04, 05, 06, 07, 08

## 1.5mm Mini Fragment System

### 1.5 MM LCP ADAPTION PLATE



**PRODUCT CODE :** GMP525  
**HOLE :** 04, 06, 08, 10, 12

### 1.5 MM LCP STRAIGHT PLATE



**PRODUCT CODE :** GMP533  
**HOLE :** 04, 05, 06, 07, 08, 10, 12

### 1.5 MM LOCKING STAR DRIVE SCREW



**PRODUCT CODE :** GMP258  
**LENGTH :** 06 MM TO 20 MM  
(Diff. 02 MM)

### 1.5 MM CORTEX STAR DRIVE SCREW



**PRODUCT CODE :** GMP260  
**LENGTH :** 06 MM TO 20 MM  
(Diff. 02 MM)

### 1.5MM MINI FRAGMENT SYSTEM - IS0009

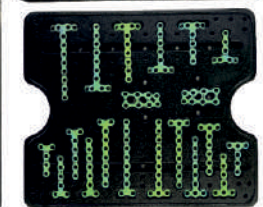
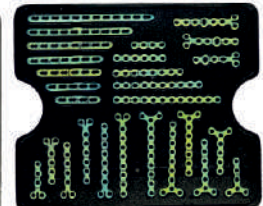

## 2.0 MM LCP STRUT PLATE



PRODUCT CODE : GMP522  
HOLE : 08  
DIRECTION : RIGHT / LEFT

## 2.0 MM LCP ROTATION CORRECTION PLATE



PRODUCT CODE : GMP524  
HOLE : 04, 05, 06

## 2.0 MM LCP CONDYLAR PLATE



PRODUCT CODE : GMP530  
HOLE : 03, 04, 05, 06, 07, 08

## 2.0 MM LCP T-PLATE 2 HEAD HOLE



PRODUCT CODE : GMP538  
HOLE : 03, 04, 05, 06, 07, 08

## 2.0 MM LCP T-PLATE 3 HEAD HOLE



PRODUCT CODE : GMP551  
HOLE : 03, 04, 05, 06, 07, 08

## 2.0 MM LCP Y-PLATE 3 HEAD HOLE



PRODUCT CODE : GMP543  
HOLE : 03, 04, 05, 06, 07, 08

## 2.0mm Mini Fragment System

### 2.0 MM LCP ADAPTION PLATE



PRODUCT CODE : GMP526  
HOLE : 04, 06, 08, 10, 12

### 2.0 MM LCP STRAIGHT PLATE



PRODUCT CODE : GMP534  
HOLE : 04, 05, 06, 07, 08, 10, 12

### 2.0 MM LOCKING STAR DRIVE SCREW



PRODUCT CODE : GMP259  
LENGTH : 06 MM TO 30 MM  
(Diff. 02 MM)

### 2.0 MM CORTEX STAR DRIVE SCREW



PRODUCT CODE : GMP261  
LENGTH : 06 MM TO 30 MM  
(Diff. 02 MM)

## 2.0 MM MINI FRAGMENT SYSTEM - IS0010

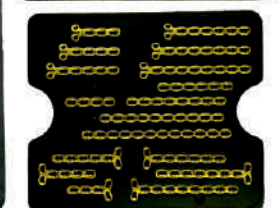
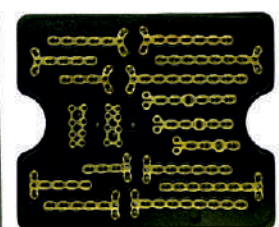
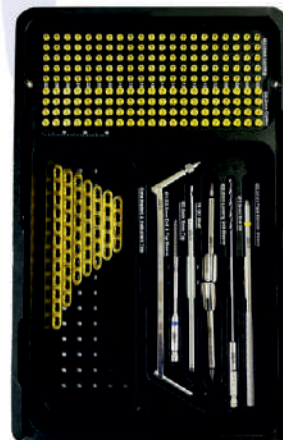



**2.4 MM LCP CONDYLAR PLATE**



**PRODUCT CODE :** GMP531  
**HOLE :** 03, 04, 05, 06, 07, 08

**2.4 MM LCP STRAIGHT PLATE**



**PRODUCT CODE :** GMP535  
**HOLE :** 04, 05, 06, 07, 08, 10, 12

**2.4 MM LCP T-PLATE 2 HEAD HOLE**



**PRODUCT CODE :** GMP539  
**HOLE :** 03, 04, 05, 06, 07, 08

**2.4 MM LOCKING STAR DRIVE SCREW**



**PRODUCT CODE :** GMP221  
**LENGTH :** 08 MM TO 30 MM  
 (Diff. 02 MM)

**2.4 MM LCP T-PLATE 3 HEAD HOLE**



**PRODUCT CODE :** GMP541  
**HOLE :** 03, 04, 05, 06, 07, 08

**2.4 MM CORTEX STAR DRIVE SCREW**



**PRODUCT CODE :** GMP262  
**LENGTH :** 08 MM TO 30 MM  
 (Diff. 02 MM)

**2.4 MM LCP Y-PLATE 3 HEAD HOLE**



**PRODUCT CODE :** GMP544  
**HOLE :** 03, 04, 05, 06, 07, 08

**2.4MM MINI FRAGMENT SYSTEM - IS0011**

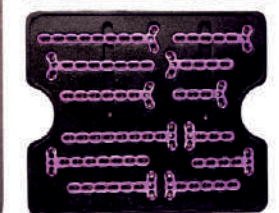
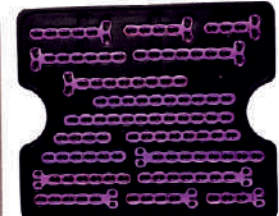

**2.4 MM LCP ADAPTION PLATE**



**PRODUCT CODE :** GMP527  
**HOLE :** 04, 06, 08, 10, 12

## 2.7 MM LCP CONDYLAR PLATE



PRODUCT CODE : GMP532  
HOLE : 03, 04, 05, 06, 07, 08

## 2.7 MM LCP T-PLATE 2 HEAD HOLE



PRODUCT CODE : GMP540  
HOLE : 03, 04, 05, 06, 07, 08

## 2.7 MM LCP L-PLATE 2 HEAD HOLE



PRODUCT CODE : GMP546  
HOLE : 03, 04  
DIRECTION : LEFT / RIGHT

## 2.7 MM LCP L-PLATE OBLIQUE 2 HEAD HOLE



PRODUCT CODE : GMP548  
HOLE : 03, 04  
DIRECTION : LEFT / RIGHT

## 2.7 MM LCP ADAPTION PLATE



PRODUCT CODE : GMP528  
HOLE : 04, 06, 08, 10, 12

## 2.7 MM LCP STRAIGHT PLATE



PRODUCT CODE : GMP536  
HOLE : 04, 05, 06, 07, 08, 10, 12

## 2.7 MM LOCKING STAR DRIVE SCREW



PRODUCT CODE : GMP224  
LENGTH : 10 MM TO 40 MM  
(Diff. 02 MM)

## 2.7 MM CORTEX MINI STAR DRIVE SCREW



PRODUCT CODE : GMP295  
LENGTH : 10 MM TO 30 MM  
(Diff. 02 MM)

## 2.7 MM MINI FRAGMENT SYSTEM - IS0012

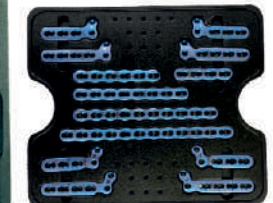
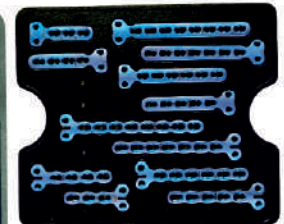



## 1.5/2.0/2.4/2.7 MM MINI FRAGMENT SYSTEM - IS0013

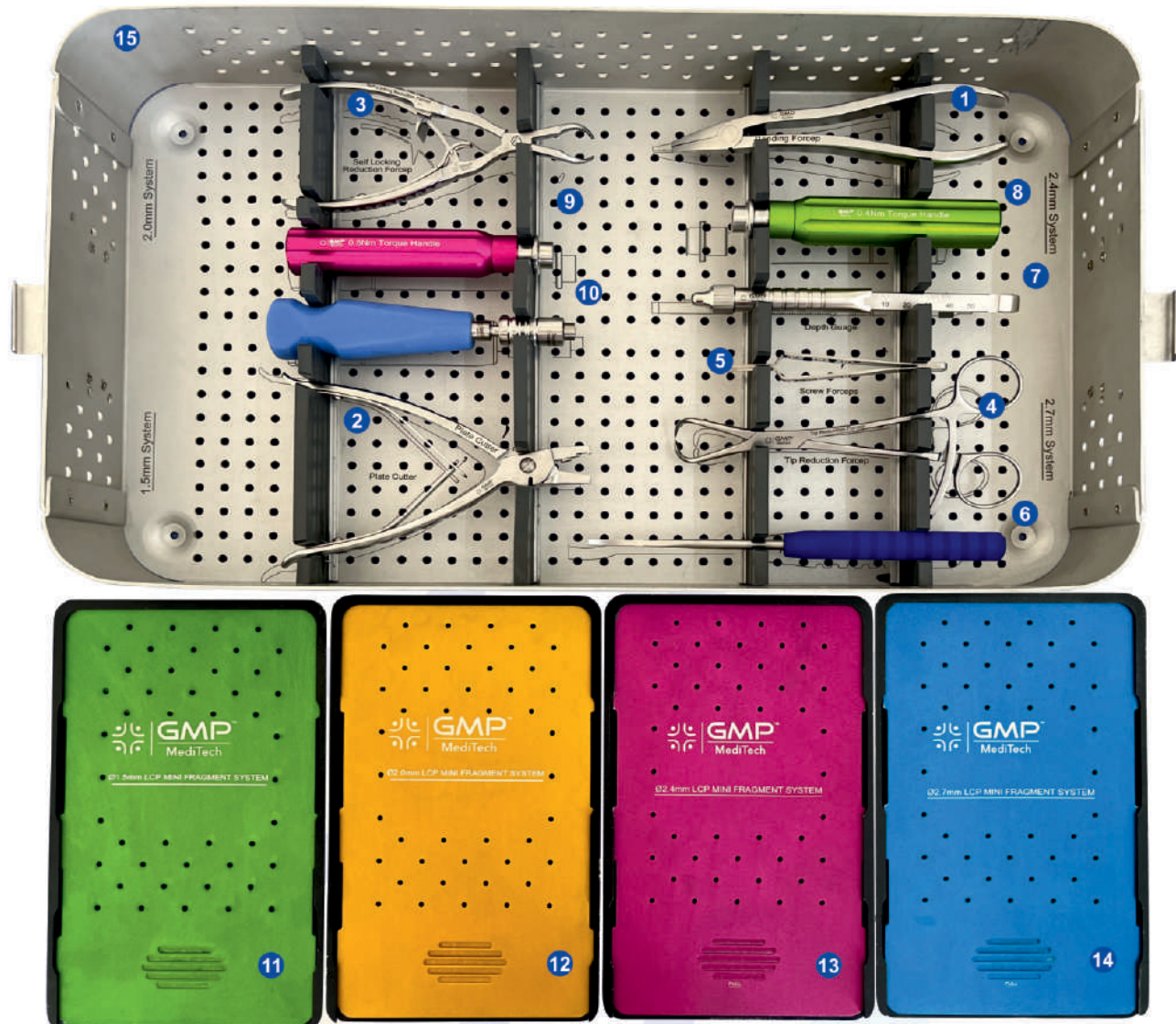

- |  |  |
|--|--|
| <ol style="list-style-type: none"> <li>1. Bending Forcep</li> <li>2. Plate Cutter</li> <li>3. Self Locking Reduction Forcep</li> <li>4. Tip Reduction Forcep</li> <li>5. Forcep for Plate and Screw</li> <li>6. Periosteal Elevator Round</li> <li>7. Depth Gauge</li> <li>8. 0.4 Nm Torque Handle for 1.5/2.0mm Mini Plate</li> <li>9. 0.8 Nm Torque Handle for 2.4/2.7mm Mini Plate</li> <li>10. Straight Quick Coupling Silicon Handle</li> </ol> | <ol style="list-style-type: none"> <li>11. 1.5mm system Alluminium Solid Graphical Box</li> <li>12. 2.0mm system Alluminium Solid Graphical Box</li> <li>13. 2.4mm system Alluminium Solid Graphical Box</li> <li>14. 2.7mm system Alluminium Solid Graphical Box</li> <li>15. Alluminium Graphical Box</li> </ol> |
|--|--|



**GMP**<sup>TM</sup>

MediTech

*Innovation for life...*



# LOCKING PLATE

A full Range of Product  
for **LOCKING PLATE**





## Ø 3.5 LCP Superior Anterior Clavicle Plate (S-Type)



**Product Code :** GMP021  
**Material :**  
 SS316L / Titanium / SS316LVM  
**Hole :**  
 05, 06, 07, 08  
**Direction :**  
 Right / Left

## Ø 2.7/3.5 LCP Superior Anterior Clavicle Plate with Lateral Extension



**Product Code :** GMP022  
**Material :**  
 SS316L / Titanium / SS316LVM  
**Hole :**  
 03, 04, 05, 06, 07, 08  
**Direction :**  
 Right / Left

## Ø 3.5 LCP Superior Anterior Clavicle Hook Plate



**Blade Height :** 12 mm  
**Product Code :** GMP023  
**Material :**  
 SS316L / Titanium / SS316LVM  
**Hole :**  
 04, 05, 06, 07, 08  
**Direction :**  
 Right / Left

**Blade Height :** 15 mm  
**Product Code :** GMP024  
**Material :**  
 SS316L / Titanium / SS316LVM  
**Hole :**  
 04, 05, 06, 07, 08  
**Direction :**  
 Right / Left

**Blade Height :** 18 mm  
**Product Code :** GMP025  
**Material :**  
 SS316L / Titanium / SS316LVM  
**Hole :**  
 04, 05, 06, 07, 08  
**Direction :**  
 Right / Left

## Ø 3.5 LCP Philos Plate - Sort



**Product Code :** GMP026  
**Material :**  
 SS316L / Titanium / SS316LVM  
**Hole :**  
 03, 04, 05, 06, 07, 08, 10

## Ø 3.5 LCP Periarticular Proximal Humerus Plate



**Product Code :** GMP028  
**Material :**  
 SS316L / Titanium / SS316LVM  
**Hole :**  
 02, 03, 04, 05, 06, 07, 08, 09, 10, 12, 14  
**Direction :**  
 Right / Left

## Ø 3.5 LCP Philos Plate - Long



**Product Code :** GMP027  
**Material :**  
 SS316L / Titanium / SS316LVM  
**Hole :**  
 03, 04, 05, 06, 07, 08, 09, 10, 12, 14

## Ø 2.7/3.5 LCP Distal Humerus Posterolateral with Lateral Support Plate



**Product Code :** GMP029  
**Material :**  
 SS316L / Titanium / SS316LVM  
**Hole :**  
 03, 05, 07, 09, 11, 14  
**Direction :**  
 Right / Left

## Ø 2.7/3.5 LCP Distal Humerus Posterolateral without Lateral Support Plate



**Product Code :** GMP030  
**Material :**  
 SS316L / Titanium / SS316LVM  
**Hole :**  
 03, 05, 07, 09, 11, 14  
**Direction :**  
 Right / Left

## Ø 2.7/3.5 LCP Distal Humerus Medial Plate



**Product Code :** GMP031  
**Material :**  
 SS316L / Titanium / SS316LVM  
**Hole :**  
 03, 05, 07, 09, 11, 14  
**Direction :**  
 Right / Left

## Ø 3.5 LCP Metaphyseal Plate

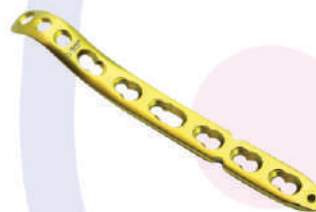

**Product Code :** GMP032  
**Material :**  
 SS316L / Titanium / SS316LVM  
**Hole :**  
 05, 07, 09, 11, 13, 15

## Ø 3.5 LCP Extra Articular Distal Humerus Plate



**Product Code :** GMP033  
**Material :**  
 SS316L / Titanium / SS316LVM  
**Hole :**  
 04, 06, 08, 10, 12, 14  
**Direction :**  
 Right / Left

## Ø 3.5 LCP Small Plate



**Product Code :** GMP084  
**Material :**  
 SS316L / Titanium / SS316LVM  
**Hole :**  
 05, 06, 07, 08, 09, 10, 11, 12

## Ø 3.5 LCP T-Oblique Plate



**Product Code :** GMP070  
**Material :**  
 SS316L / Titanium / SS316LVM  
**Hole :**  
 03, 04, 05, 06, 07, 08, 09, 10  
**Direction :**  
 Right / Left

## Ø 3.5 LCP T-Right Angle Plate



**Product Code :** GMP071  
**Material :**  
 SS316L / Titanium / SS316LVM  
**Hole :**  
 03, 04, 05, 06, 07, 08, 09, 10,  
 11, 12

## Ø 3.5 LCP RCP Plate - Combi Hole



**Product Code :** GMP067  
**Material :**  
 SS316L / Titanium / SS316LVM  
**Hole :**  
 05, 06, 07, 08, 09, 10, 11, 12

## Ø 3.5 LCP Olecranon Plate



**Product Code :** GMP034  
**Material :**  
 SS316L / Titanium / SS316LVM  
**Hole :**  
 04, 06, 08, 10, 12, 14  
**Direction :**  
 Right / Left



## Ø 2.7/3.5 LCP Duraline Distal Kopsis Plate - STD



**Product Code :** GMP038  
**Material :**  
 SS316L / Titanium / SS316LVM  
**Hole :**  
 03, 04, 05, 06, 07, 08  
**Direction :**  
 Right / Left

## Ø 2.7 LCP Distal Radius Dorsal Straight Plate



**Product Code :** GMP043  
**Material :**  
 SS316L / Titanium / SS316LVM  
**Hole :**  
 04, 05, 06

## Ø 2.7/3.5 LCP Duraline Distal Kopsis Plate - WIDE



**Product Code :** GMP039  
**Material :**  
 SS316L / Titanium / SS316LVM  
**Hole :**  
 03, 04, 05, 06, 07, 08  
**Direction :**  
 Right / Left

## Ø 2.7 LCP Distal Radius Dorsal L- Plate 2 Head Hole



**Product Code :** GMP044  
**Material :**  
 SS316L / Titanium / SS316LVM  
**Hole :**  
 03, 04, 05  
**Direction :**  
 Right / Left

## Ø 2.7 LCP Distal Radius Extra Articular 4 Head Hole Plate



**Product Code :** GMP040  
**Material :**  
 SS316L / Titanium / SS316LVM  
**Hole :**  
 03, 04, 05, 06  
**Direction :**  
 Right / Left

## Ø 2.7 LCP Distal Radius Dorsal L- Plate 3 Head Hole



**Product Code :** GMP045  
**Material :**  
 SS316L / Titanium / SS316LVM  
**Hole :**  
 03, 04, 05  
**Direction :**  
 Right / Left

## Ø 2.7 LCP Distal Radius Extra Articular 5 Head Hole Plate



**Product Code :** GMP041  
**Material :**  
 SS316L / Titanium / SS316LVM  
**Hole :**  
 03, 04, 05, 06  
**Direction :**  
 Right / Left

## Ø 2.7 LCP Distal Radius Dorsal Oblique Plate 3 Head Hole



**Product Code :** GMP046  
**Material :**  
 SS316L / Titanium / SS316LVM  
**Hole :**  
 03, 04, 05  
**Direction :**  
 Right / Left

## Ø 2.7 LCP Distal Radius Jextra Articular 5 Head Hole Plate



**Product Code :** GMP042  
**Material :**  
 SS316L / Titanium / SS316LVM  
**Hole :**  
 03, 04, 05, 06  
**Direction :**  
 Right / Left

## Ø 2.7 LCP Distal Radius Dorsal T-Plate



**Product Code :** GMP047  
**Material :**  
 SS316L / Titanium / SS316LVM  
**Hole :**  
 03, 04, 05

## Ø 2.7 LCP Radial Head Rim Plate



**Product Code :** GMP048  
**Material :**  
 SS316L / Titanium / SS316LVM  
**Hole :**  
 02, 03, 04, 05  
**Direction :**  
 Right / Left

## Ø 2.7 LCP Radial Head Neck Plate



**Product Code :** GMP049  
**Material :**  
 SS316L / Titanium / SS316LVM  
**Hole :**  
 02, 03, 04, 05

## Ø 2.4/2.7 LCP Variable Angle Two Column Volar Plate - STD



**Product Code :** GMP036  
**Material :**  
 SS316L / Titanium / SS316LVM  
**Hole :**  
 02, 03, 04, 05, 06, 07  
**Direction :**  
 Right / Left

## Ø 2.4/2.7 LCP Variable Angle Two Column Volar Plate - WIDE



**Product Code :** GMP037  
**Material :**  
 SS316L / Titanium / SS316LVM  
**Hole :**  
 02, 03, 04, 05, 06, 07  
**Direction :**  
 Right / Left

## Ø 2.4/2.7 LCP Variable Angle Rim Plate - STD



**Product Code :** GMP101  
**Material :**  
 SS316L / Titanium / SS316LVM  
**Hole :**  
 03, 04, 05  
**Direction :**  
 Right / Left

## Ø 2.4/2.7 LCP Variable Angle Rim Plate - WIDE



**Product Code :** GMP102  
**Material :**  
 SS316L / Titanium / SS316LVM  
**Hole :**  
 03, 04, 05  
**Direction :**  
 Right / Left

# Variable Angle



## Ø 4.5/5.0 LCP Lateral Tibia Plate



**Product Code :** GMP055  
**Material :**  
 SS316L / Titanium / SS316LVM  
**Hole :**  
 03, 05, 07, 09, 11, 13, 15, 17  
**Direction :**  
 Right / Left

## Ø 3.5 LCP Distal Medial Tibia with Tab Plate



**Product Code :** GMP060  
**Material :**  
 SS316L / Titanium / SS316LVM  
**Hole :**  
 04, 06, 08, 10, 12, 14  
**Direction :**  
 Right / Left

## Ø 3.5 LCP Proximal Lateral Tibia Plate (Raft)



**Product Code :** GMP056  
**Material :**  
 SS316L / Titanium / SS316LVM  
**Hole :**  
 04, 06, 08, 10, 12, 14, 16  
**Direction :**  
 Right / Left

## Ø 3.5 LCP Anterolateral Distal Tibia Plate



**Product Code :** GMP061  
**Material :**  
 SS316L / Titanium / SS316LVM  
**Hole :**  
 05, 07, 09, 11, 13, 15, 17  
**Direction :**  
 Right / Left

## Ø 3.5 LCP Proximal Medial Tibia T-Type Plate



**Product Code :** GMP057  
**Material :**  
 SS316L / Titanium / SS316LVM  
**Hole :**  
 04, 06, 08, 10, 12, 14, 16  
**Direction :**  
 Right / Left

## Ø 4.5/5.0 LCP L-Buttress Plate



**Product Code :** GMP076  
**Material :**  
 SS316L / Titanium / SS316LVM  
**Hole :**  
 03, 04, 05, 06, 07, 08, 09, 10, 12  
**Direction :**  
 Right / Left

## Ø 3.5 LCP Posterior Medial Proximal Tibia Plate



**Product Code :** GMP058  
**Material :**  
 SS316L / Titanium / SS316LVM  
**Hole :**  
 03, 04, 05, 06, 07, 08, 09, 10

## Ø 4.5/5.0 LCP T-Buttress Plate



**Product Code :** GMP077  
**Material :**  
 SS316L / Titanium / SS316LVM  
**Hole :**  
 03, 04, 05, 06, 07, 08, 09, 10, 12

## Ø 3.5 LCP Distal Medial Tibia Plate



**Product Code :** GMP059  
**Material :**  
 SS316L / Titanium / SS316LVM  
**Hole :**  
 04, 06, 08, 10, 12, 14  
**Direction :**  
 Right / Left

## Ø 4.5/5.0 LCP T- Plate



**Product Code :** GMP078  
**Material :**  
 SS316L / Titanium / SS316LVM  
**Hole :**  
 03, 04, 05, 06, 07, 08, 09, 10, 12

## Ø 4.5/5.0 LCP Tibia Tomofix Plate (Std/Wide)



**Product Code :**  
GMP120/GMP068  
**Material :**  
SS316L / Titanium  
**Hole :**  
03, 04

## Ø 4.5/5.0 LCP Medial Femur Osteotomy Plate



**Product Code :** GMP069  
**Material :**  
SS316L / Titanium  
**Hole :**  
04  
**Direction :**  
Right / Left

## Ø 4.5/5.0 LCP Distal Femur Plate



**Product Code :** GMP062  
**Material :**  
SS316L / Titanium / SS316LVM  
**Hole :**  
03, 05, 07, 09, 11, 13, 15, 17  
**Direction :**  
Right / Left

## Ø 4.5/5.0 LCP NARROW PLATE



**Product Code :** GMP074  
**Material :**  
SS316L / Titanium / SS316LVM  
**Hole :**  
05, 06, 07, 08, 09, 10, 11, 12

## Ø 4.5/5.0 LCP Proximal Femur Plate

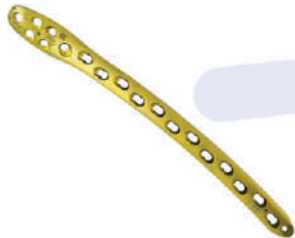

**Product Code :** GMP063  
**Material :**  
SS316L / Titanium / SS316LVM  
**Hole :**  
02, 04, 06, 08, 10, 12  
**Direction :**  
Right / Left

## Dynamic Hip Compression Plate (130°)



**Product Code :** GMP091  
**Material :**  
SS316L / Titanium / SS316LVM  
**Hole :**  
04, 05, 06, 08, 10, 12  
**Barrel Length :**  
38 mm

## Ø 4.5/5.0 LCP Medial Femur Plate



**Product Code :** GMP100  
**Material :**  
SS316L / Titanium / SS316LVM  
**Hole :**  
02, 04, 06, 08  
**Direction :**  
Right / Left

## Dynamic Hip Compression Plate (135°)



**Product Code :** GMP092  
**Material :**  
SS316L / Titanium / SS316LVM  
**Hole :**  
04, 05, 06, 08, 10, 12  
**Barrel Length :**  
38 mm

## Ø 4.5/5.0 LCP Broad Plate



**Product Code :** GMP075  
**Material :**  
SS316L / Titanium / SS316LVM  
**Hole :**  
05, 06, 07, 08, 09, 10, 11, 12

## Dynamic Hip Compression Screw



**Product Code :** GMP300  
**Material :**  
SS316LVM / Titanium  
**Length :**  
50 to 120 mm (Diff. 05mm)

# Femur



## Ø 3.5 LCP Lateral Distal Fibula Plate



**Product Code :** GMP064  
**Material :**  
 SS316L / Titanium / SS316LVM  
**Hole :**  
 03, 04, 05, 06, 07

## Ø 2.7/3.5 LCP VA Distal Fibula Plate



**Product Code :** GMP096  
**Material :**  
 SS316L / Titanium / SS316LVM  
**Hole :**  
 03, 04, 05, 06, 07, 09, 11, 13  
**Direction :**  
 Right / Left

## Ø 3.5 LCP One Third Tubular Plate



**Product Code :** GMP073  
**Material :**  
 SS316L / Titanium / SS316LVM  
**Hole :**  
 05, 06, 07, 08, 09, 10, 12

## Ø 3.5 LCP CALCANIUM PLATE



**Product Code :** GMP035  
**Material :**  
 SS316L / Titanium / SS316LVM  
**Size :**  
 64, 69, 76, 81



**GMP™**

MediTech

*Innovation for life...*



# NON- LOCKING PLATE

A full Range of Product  
for **LOCKING PLATE**

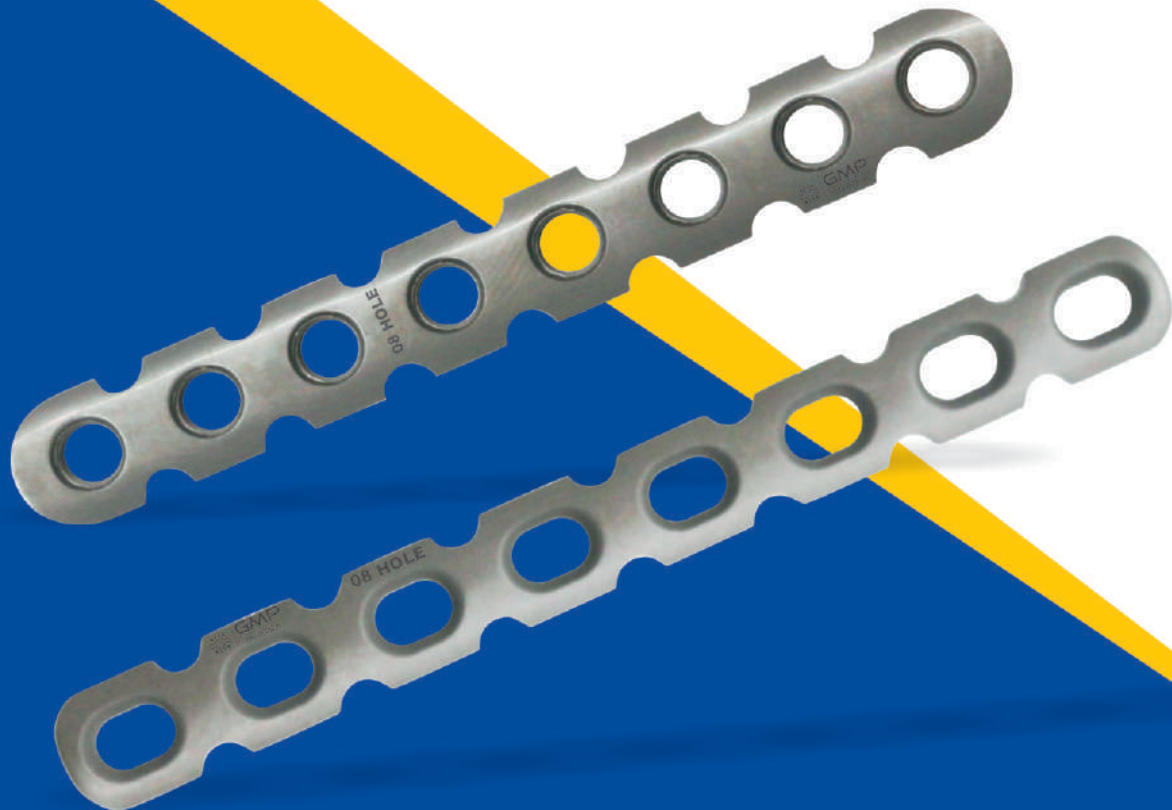



## 3.5 DCP Small Plate



**Product Code :** GMP082  
**Material :**  
SS316L / Titanium  
**Hole :**  
05, 06, 07, 08, 09, 10, 11, 12

## 3.5 LC-DCP Small Plate



**Product Code :** GMP110  
**Material :**  
SS316L / Titanium  
**Hole :**  
05, 06, 07, 08, 09, 10, 11, 12

## 3.5 DCP One Third Plate - Round Hole



**Product Code :** GMP086  
**Material :**  
SS316L / Titanium  
**Hole :**  
05, 06, 07, 08, 09, 10, 11, 12

## 3.5 DCP Reconstruction Plate - Round Hole



**Product Code :** GMP079  
**Material :**  
SS316L / Titanium  
**Hole :**  
05, 06, 07, 08, 09, 10, 11, 12

## 3.5 DCP Reconstruction Plate



**Product Code :** GMP111  
**Material :**  
SS316L / Titanium  
**Hole :**  
05, 06, 07, 08, 09, 10, 11, 12

## 4.5 DCP Broad Plate



**Product Code :** GMP112  
**Material :**  
SS316L / Titanium  
**Hole :**  
05, 06, 07, 08, 09, 10, 11, 12

## 4.5 DCP Narrow Plate



**Product Code :** GMP083  
**Material :**  
SS316L / Titanium  
**Hole :**  
05, 06, 07, 08, 09, 10, 11, 12

## 4.5 LC-DCP Narrow Plate



**Product Code :** GMP113  
**Material :**  
SS316L / Titanium  
**Hole :**  
05, 06, 07, 08, 09, 10, 11, 12

## Ø 2.4mm VA Locking STAR Drive Screw



**Product Code :** GMP221  
**Material :**  
 SS316L / Titanium / SS316LVM  
**Length :**  
 06 to 30 mm (Diff. 02 mm)

## Ø 2.4mm Cortex STAR Drive Screw



**Product Code :** GMP262  
**Material :**  
 SS316L / Titanium / SS316LVM  
**Length :**  
 06 to 30 mm (Diff. 02 mm)

## Ø 2.7mm Locking HEX Drive Screw



**Product Code :** GMP255  
**Material :**  
 SS316L / Titanium / SS316LVM  
**Length :**  
 10 to 50 mm (Diff. 02 mm)

## Ø 2.7mm Locking STAR Drive Screw



**Product Code :** GMP224  
**Material :**  
 SS316L / Titanium / SS316LVM  
**Length :**  
 10 to 50 mm (Diff. 02 mm)

## Ø 2.7mm Cortex HEX Drive Screw



**Product Code :** GMP223  
**Material :**  
 SS316L / Titanium / SS316LVM  
**Length :**  
 10 to 30 mm (Diff. 02 mm)

## Ø 2.7mm Cortex STAR Drive Screw



**Product Code :** GMP222  
**Material :**  
 SS316L / Titanium / SS316LVM  
**Length :**  
 10 to 30 mm (Diff. 02 mm)

## Ø 3.5mm Cortex HEX Drive Screw



**Product Code :** GMP225  
**Material :**  
 SS316L / Titanium / SS316LVM  
**Length :**  
 12 to 50 mm (Diff. 02 mm)

## Ø 3.5mm Cortex STAR Drive Screw



**Product Code :** GMP226  
**Material :**  
 SS316L / Titanium / SS316LVM  
**Length :**  
 12 to 50 mm (Diff. 02 mm)

## Ø 3.5mm Locking HEX Drive Screw



**Product Code :** GMP227  
**Material :**  
 SS316L / Titanium / SS316LVM  
**Length :**  
 12 to 60 mm (Diff. 02 mm)  
 65 to 90 mm (Diff. 05 mm)

## Ø 3.5mm Locking STAR Drive Screw



**Product Code :** GMP228  
**Material :**  
 SS316L / Titanium / SS316LVM  
**Length :**  
 12 to 60 mm (Diff. 02 mm)  
 65 to 90 mm (Diff. 05 mm)

## Ø 3.5mm Cancellous Locking HEX Drive Screw



**Product Code :** GMP229  
**Material :**  
 SS316L / Titanium / SS316LVM  
**Length :**  
 12 to 30 mm (Diff. 02 mm)  
 35 to 70 mm (Diff. 05 mm)

## Ø 3.5mm Cancellous Locking STAR Drive Screw



**Product Code :** GMP230  
**Material :**  
 SS316L / Titanium / SS316LVM  
**Length :**  
 12 to 30 mm (Diff. 02 mm)  
 35 to 70 mm (Diff. 05 mm)



## Ø 4.5mm Cortex HEX Drive Screw



**Product Code :** GMP231  
**Material :**  
 SS316L / Titanium / SS316LVM  
**Length :**  
 18 to 50 mm (Diff. 02 mm)  
 55 to 75 mm (Diff. 05 mm)

## Ø 4.5mm Cortex STAR Drive Screw



**Product Code :** GMP253  
**Material :**  
 SS316L / Titanium / SS316LVM  
**Length :**  
 18 to 50 mm (Diff. 02 mm)  
 55 to 75 mm (Diff. 05 mm)

## Ø 5.0mm Locking HEX Drive Screw



**Product Code :** GMP232  
**Material :**  
 SS316L / Titanium / SS316LVM  
**Length :**  
 18 to 60 mm (Diff. 02 mm)  
 65 to 95 mm (Diff. 05 mm)

## Ø 5.0mm Locking STAR Drive Screw



**Product Code :** GMP233  
**Material :**  
 SS316L / Titanium / SS316LVM  
**Length :**  
 18 to 60 mm (Diff. 02 mm)  
 65 to 95 mm (Diff. 05 mm)

## Ø 5.0mm Cancellous Locking HEX Drive Screw



**Product Code :** GMP234  
**Material :**  
 SS316L / Titanium / SS316LVM  
**Length :**  
 20 to 90 mm (Diff. 05 mm)

## Ø 5.0mm Cancellous Locking STAR Drive Screw



**Product Code :** GMP235  
**Material :**  
 SS316L / Titanium / SS316LVM  
**Length :**  
 20 to 90 mm (Diff. 05 mm)

## Ø 4.0mm Cancellous HEX Drive Screw Partially Threaded



**Product Code :** GMP237  
**Material :**  
 SS316L / Titanium / SS316LVM  
**Length :**  
 25 to 70 mm (Diff. 05 mm)

## Ø 4.0mm Cancellous HEX Drive Screw Fully Threaded



**Product Code :** GMP236  
**Material :**  
 SS316L / Titanium / SS316LVM  
**Length :**  
 25 to 70 mm (Diff. 05 mm)

## Ø 6.5mm Cancellous HEX Drive Screw 16mm Partially Threaded



**Product Code :** GMP240  
**Material :**  
 SS316L / Titanium / SS316LVM  
**Length :**  
 50 to 110 mm (Diff. 05 mm)

## Ø 6.5mm Cancellous HEX Drive Screw 32mm Partially Threaded



**Product Code :** GMP241  
**Material :**  
 SS316L / Titanium / SS316LVM  
**Length :**  
 50 to 110 mm (Diff. 05 mm)

## Ø 6.5mm Cancellous HEX Drive Screw Fully Threaded



**Product Code :** GMP239  
**Material :**  
 SS316L / Titanium / SS316LVM  
**Length :**  
 50 to 110 mm (Diff. 05 mm)

## Ø 6.0mm LHS Cannulated HEX Drive Screw Fully Threaded



**Product Code :** GMP270  
**Material :**  
 SS316L / Titanium / SS316LVM  
**Length :**  
 55 to 120 mm (Diff. 05 mm)

## Ø 4.0mm Cannulated Cancellous HEX Drive Screw Partially Threaded



**Product Code :** GMP242  
**Material :**  
 SS316L / Titanium / SS316LVM  
**Length :**  
 20 to 70 mm (Diff. 05 mm)

## Ø 4.0mm Cannulated Cancellous HEX Drive Screw fully Threaded



**Product Code :** GMP243  
**Material :**  
 SS316L / Titanium / SS316LVM  
**Length :**  
 20 to 70 mm (Diff. 05 mm)

## Ø 6.5mm Cannulated Cancellous HEX Drive Screw 16mm Partially Threaded



**Product Code :** GMP244  
**Material :**  
 SS316L / Titanium / SS316LVM  
**Length :**  
 50 to 110 mm (Diff. 05 mm)

## Ø 6.5mm Cannulated Cancellous HEX Drive Screw 32mm Partially Threaded



**Product Code :** GMP245  
**Material :**  
 SS316L / Titanium / SS316LVM  
**Length :**  
 50 to 110 mm (Diff. 05 mm)

## Ø 3.5mm Spacer



**Product Code :** GMP256  
**Material :**  
 SS316L / Titanium / SS316LVM

## Ø 5.0mm Spacer



**Product Code :** GMP257  
**Material :**  
 SS316L / Titanium / SS316LVM

## Ø 3.5mm Wire Mount



**Product Code :** GMP267  
**Material :**  
 SS316L / Titanium / SS316LVM

## Ø 5.0mm Wire Mount



**Product Code :** GMP268  
**Material :**  
 SS316L / Titanium / SS316LVM

## Ø2.4mm Herbert Screw- Short Threaded



**Product Code :** GMP271  
**Material :**  
 Titanium  
**Length :**  
 12 to 40 mm (Diff. 02 mm)

## Ø3.0mm Herbert Screw- Short Threaded



**Product Code :** GMP272  
**Material :**  
 Titanium  
**Length :**  
 12 to 40 mm (Diff. 02 mm)

## Ø3.5mm Herbert Screw- Short Threaded



**Product Code :** GMP273  
**Material :**  
 Titanium  
**Length :**  
 12 to 40 mm (Diff. 02 mm)

## Ø4.0mm Herbert Screw- Short Threaded



**Product Code :** GMP274  
**Material :**  
 Titanium  
**Length :**  
 30 to 80 mm (Diff. 02 mm)





**GMP™**

MediTech

*Innovation for life...*



# PELVIC SYSTEM

A full Range of Product  
for **PELVIC PLATE**



## Ø3.5 Low Profile Pelvic Reconstruction 88mm Curved Plate



**Product Code :** GMP051  
**Material :**  
 SS316LVM  
**Hole :**  
 06, 08, 10, 12, 14, 16

## Ø3.5 Low Profile Pelvic Reconstruction 108mm Curved Plate



**Product Code :** GMP052  
**Material :**  
 SS316LVM  
**Hole :**  
 06, 08, 10, 12, 14, 16

## Ø3.5 Low Profile Pelvic Reconstruction 88mm J-Plate



**Product Code :** GMP053  
**Material :**  
 SS316LVM  
**Hole :**  
 10, 12, 14, 16  
**Direction :**  
 Right / Left

## Ø3.5 Low Profile Pelvic Reconstruction 108mm J- Plate



**Product Code :** GMP054  
**Material :**  
 SS316LVM  
**Hole :**  
 10, 12, 14, 16  
**Direction :**  
 Right / Left

## Ø3.5 Low Profile Pelvic Reconstruction Plate



**Product Code :** GMP050  
**Material :**  
 SS316LVM  
**Hole :**  
 03, 04, 05, 06, 07, 08, 09,  
 10, 11, 12, 13, 14, 15, 16,  
 18, 20

## Ø3.5 Symphyseal Pelvic Plate



**Product Code :** GMP104  
**Material :**  
 SS316LVM  
**Hole :**  
 04, 06

## Ø3.5 Quadrilateral Surface Pelvic Plate



**Product Code :** GMP107  
**Material :**  
 SS316LVM  
**Size :**  
 Short, Standard, Long

## Ø3.5 Spring Pelvic Plate



**Product Code :** GMP103  
**Material :**  
 SS316LVM  
**Hole :**  
 01, 02, 03



## Ø3.5mm Cortex Hex Drive Screw



**Product Code :** GMP275  
**Material :**  
 SS316LVM  
**Length :**  
 12 to 50 mm (Diff. 02mm)  
 55 to 95 mm (Diff. 02mm)

## Ø3.5mm Cortex Star Drive Screw



**Product Code :** GMP276  
**Material :**  
 SS316LVM  
**Length :**  
 12 to 50 mm (Diff. 02mm)  
 55 to 95 mm (Diff. 02mm)

## Ø4.0mm Cancellous Star Drive Screw



**Product Code :** GMP277  
**Material :**  
 SS316LVM / Titanium  
**Length :**  
 12 to 50 mm (Diff. 02mm)  
 55 to 100 mm (Diff. 05mm)

## Pelvic Implant Set - B00021

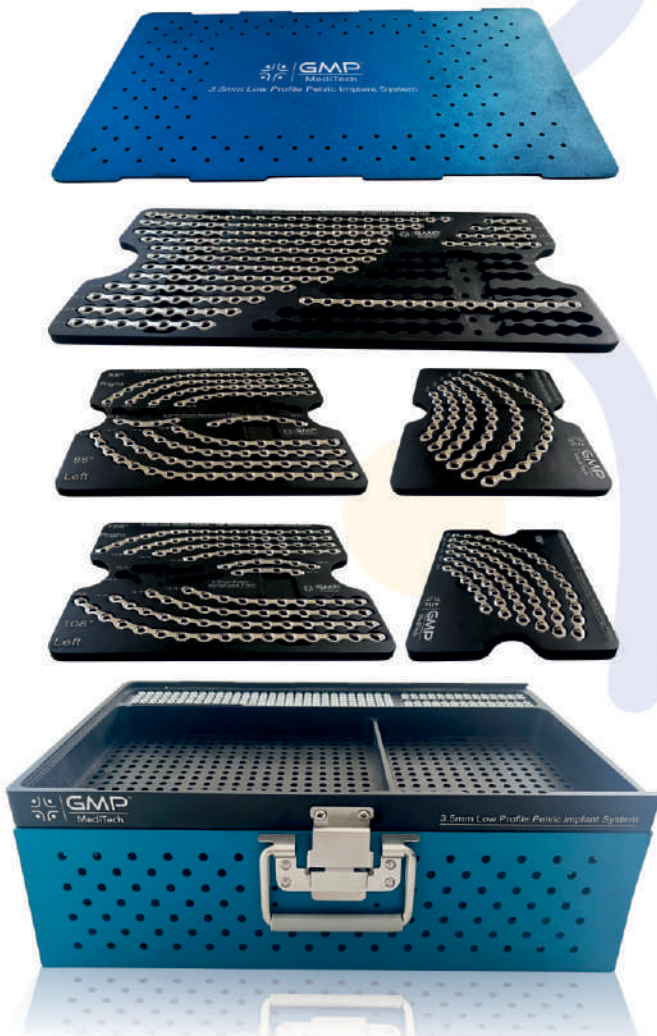

# Implant & Instrument Set

## Pelvic Instrument Set - IS0014

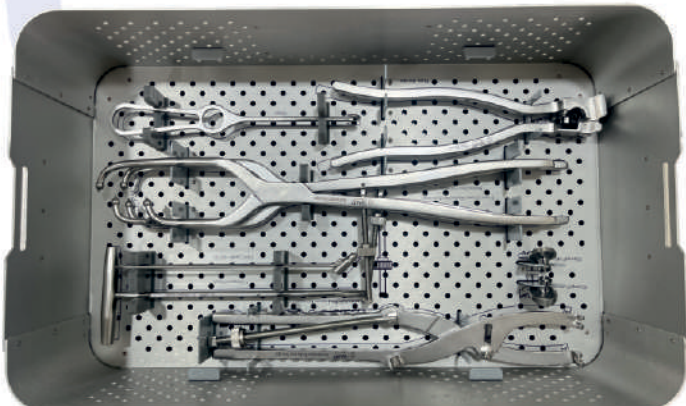
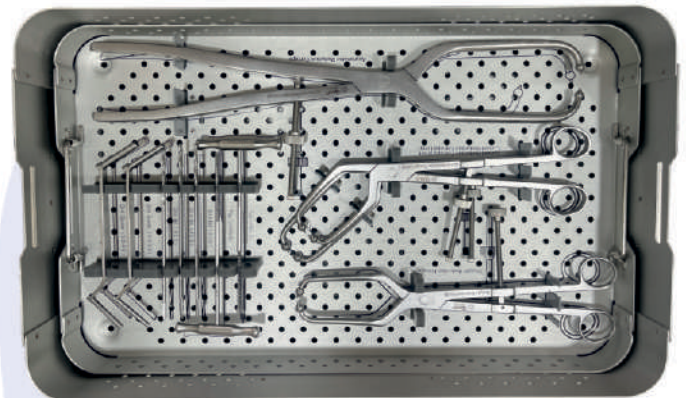
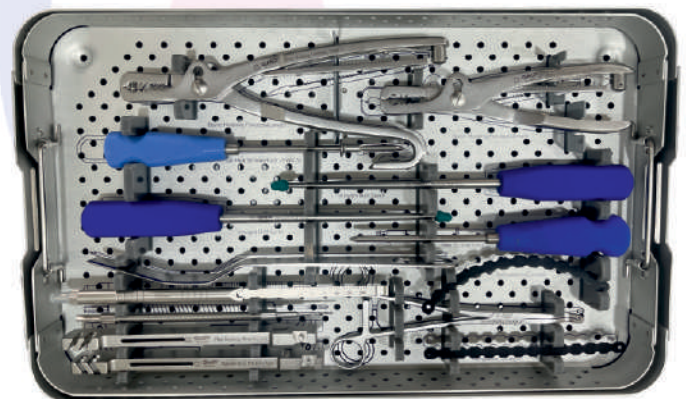



# Ø2.4/2.7mm VA Two Column & Rim Implant with Instrument Set - IS0002

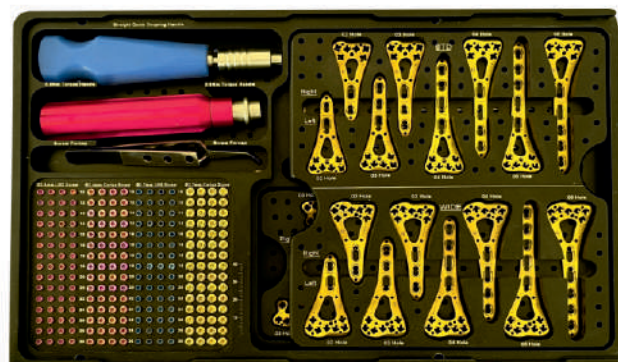

SR.NO.	PRODUCT CODE	PRODUCT NAME	QTY.
1	GW0001	Guidar Wire (Pointed) Ø1.2mm x 6"	2
2	DBQ0003	Drill Bit Ø1.8 x 4.5" Quick Coupling	2
3	DBQ0005	Drill Bit Ø2.0 x 4.5" Quick Coupling	2
4	QCS0001	T8 QC Shaft	2
5	TH0004	Torque Limiting Handle 0.8Nm - Alluminium	1
6	SQH0002	Quick Coupling Silicon Handle-For 2.4/2.7/3.5mm Screw	1
7	LDS0004	Ø2.4/2.7mm LHS Drill Sleeve - 50.0mm	2
8	DEDS004	Double Drill Sleeve 2.0mm/2.7mm	1
9	DEDS009	Double Drill Sleeve VA 1.8mm/2.0mm - VA Box	1
10	DG0001	Depth Gauge 0-50mm	1
11	SF0001	Screw Forcep	1
12	BO0002	Ø2.4/2.7mm Variable Angle with RIM Implant & Instrument System - GMP MediTech Design	1



# Ø2.7/3.5mm Instrument Set (For Volar & Clavicle Segment) - IS0018



SR.NO.	PRODUCT CODE	PRODUCT NAME	QTY.
1	TH0004	Torque Limiting Handle 0.8Nm - Alluminium	1
2	TH0007	Torque Limiting Handle 1.2Nm - Alluminium	1
3	SQH0002	Quick Coupling Silicon Handle-For 2.4/2.7/3.5mm Screw	1
4	DG0001	Depth Gauge 0-50mm	1
5	SF0001	Screw Forcep	1
6	LDS0004	Ø2.4/2.7mm LHS Drill Sleeve - 50.0mm	2
7	LDS0005	Ø3.5mm LHS Drill Sleeve Short - 60.0mm	2
8	GW0001	Guider Wire (Pointed) Ø1.2mm x 6"	2
9	GW0002	Guider Wire (Pointed) Ø1.5mm x 6"	2
10	BTQ0004	Ø2.7mm Cortex Bone Tap Quick Coupling	1
11	BTQ0005	Ø3.5mm Cortex Bone Tap Quick Coupling	1
12	DEDS004	Double Drill Sleeve 2.0mm/2.7mm	1
13	DEDS006	Double Drill Sleeve 2.5mm/3.5mm	1
14	QCS0001	T8 QC Shaft	2
15	QCS0004	2.5 SW for 3.5mm Hex Screw Shaft	2
16	DBQ0006	Drill Bit Ø2.0 x 6" Quick Coupling	2
17	DBQ0007	Drill Bit Ø2.5 x 6" Quick Coupling	2
18	DBQ0010	Drill Bit Ø2.8 x 6" Quick Coupling	2
19	BO0024	Ø2.7/3.5mm Solid Instrument Box Only - GMP MediTech Design	1



# Ø2.4/2.7/3.5mm Instrument Set (Volar/Humerus/Clavicle/Small Fragment/Fibula) - IS0003



SR.NO.	PRODUCT CODE	PRODUCT NAME	QTY.
1	TH0004	Torque Limiting Handle 0.8Nm - Alluminium	1
2	TH0007	Torque Limiting Handle 1.2Nm - Alluminium	1
3	SQH0002	Quick Coupling Silicon Handle-For 2.4/2.7/3.5mm Screw	1
4	DG0001	Depth Gauge 0-50mm	1
5	SF0001	Screw Forcep	1
6	LDS0004	Ø2.4/2.7mm LHS Drill Sleeve - 50.0mm	2
7	LDS0005	Ø3.5mm LHS Drill Sleeve Short - 60.0mm	2
8	GW0001	Guider Wire (Pointed) Ø1.2mm x 6"	2
9	GW0002	Guider Wire (Pointed) Ø1.5mm x 6"	2
10	BTQ0004	Ø2.7mm Cortex Bone Tap Quick Coupling	1
11	BTQ0005	Ø3.5mm Cortex Bone Tap Quick Coupling	1
12	DEDS004	Double Drill Sleeve 2.0mm/2.7mm	1
13	DEDS006	Double Drill Sleeve 2.5mm/3.5mm	1
14	DEDS009	Double Drill Sleeve VA 1.8mm/2.0mm - VA Box	1
15	QCS0001	T8 QC Shaft	2
16	QCS0004	2.5 SW for 3.5mm Hex Screw Shaft	2
17	DBQ0004	Drill Bit Ø1.8 x 6" Quick Coupling	2
18	DBQ0006	Drill Bit Ø2.0 x 6" Quick Coupling	2
19	DBQ0007	Drill Bit Ø2.5 x 6" Quick Coupling	2
20	DBQ0010	Drill Bit Ø2.8 x 6" Quick Coupling	2
21	BO0003	Ø2.4/2.7/3.5mm Solid Instrument Box Only - GMP MediTech Design	1



# 3.5mm Solid Instrument System – IS0015

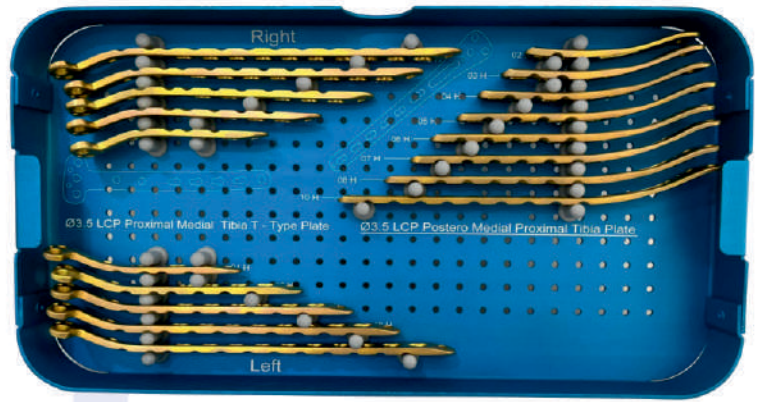

SR.NO.	PRODUCT CODE	PRODUCT NAME	QTY.
1	GW0002	Guider Wire (Pointed) Ø1.5mm x 6"	2
2	GW0005	Guider Wire (Pointed) Ø1.8mm x 6"	2
3	SD0004	2.5 SW for 3.5mm Hex Screw Silicon Handle Screw Driver	1
4	TTQ0001	Quick Coupling T- Handle-STD	1
5	TH0005	Torque Limiting Handle 1.5Nm - Alluminium	1
6	DG0003	Depth Gauge 0-100mm	1
7	LDS0006	Ø3.5mm LHS Drill Sleeve Long - 80.0mm	2
8	QCS0004	2.5 SW for 3.5mm Hex Screw Shaft	2
9	BTQ0005	Ø3.5mm Cortex Bone Tap Quick Coupling	1
10	DBQ0007	Drill Bit Ø2.5 x 6" Quick Coupling	2
11	DBQ0010	Drill Bit Ø2.8 x 6" Quick Coupling	2
12	DBQ0011	Drill Bit Ø2.8 x 8" Quick Coupling	2
13	DBS0018	Drill Bit Ø3.2 x 6" CC Solid	1
14	DEDS006	Double Drill Sleeve 2.5mm/3.5mm	1
15	BO0020	Ø3.5mm Solid Graphical Instrument Box Only	1

# Ø2.7/3.5mm Instrument Set (Volar/Humerus/Clavicle/Small Fragment) - IS0004

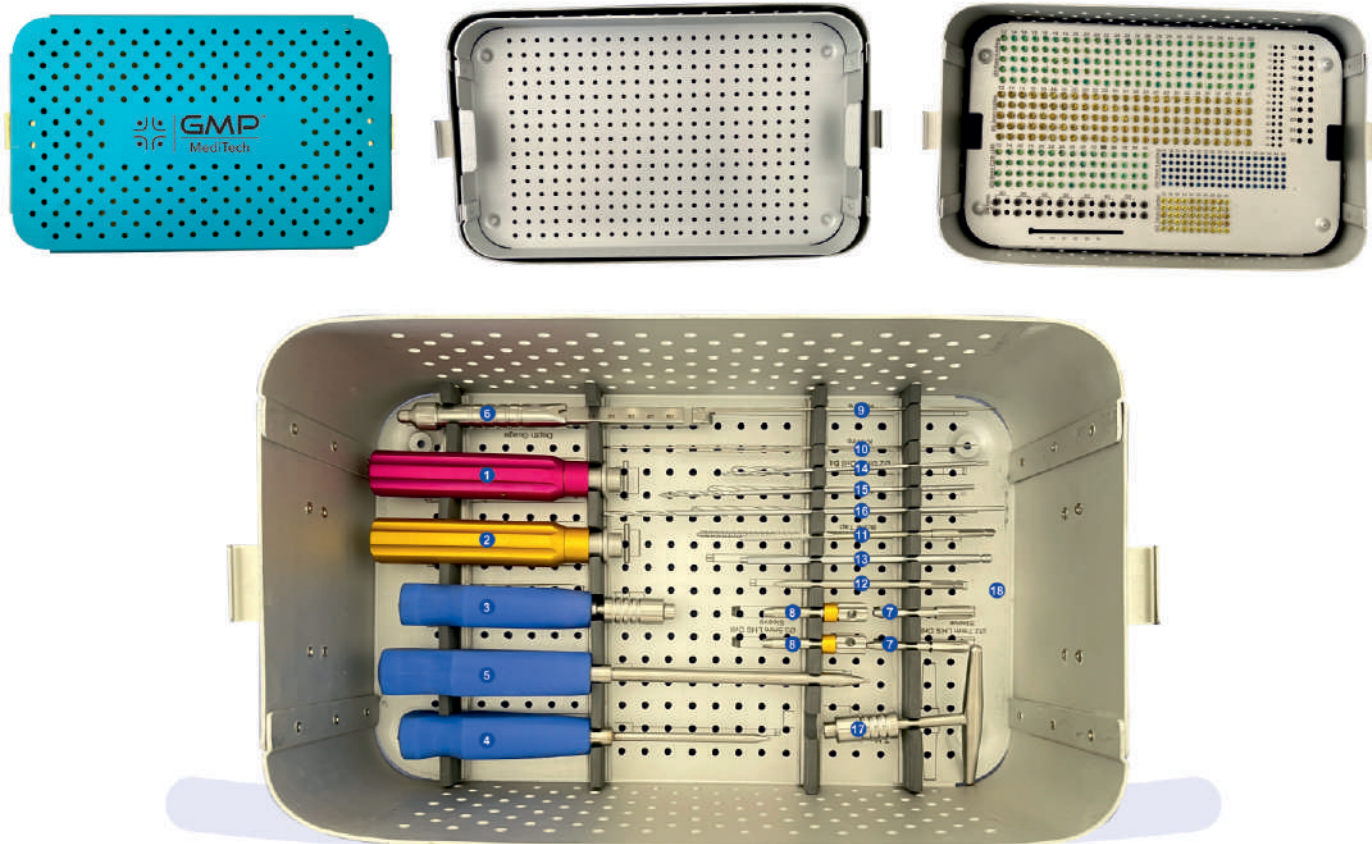

SR.NO.	PRODUCT CODE	PRODUCT NAME	QTY.
1	TH0004	Torque Limiting Handle 0.8Nm - Alluminium	1
2	TH0007	Torque Limiting Handle 1.2Nm - Alluminium	1
3	SQH0002	Quick Coupling Silicon Handle-For 2.4/2.7/3.5mm Screw	1
4	SD0001	T8 QC Silicon Handle Screw Driver	1
5	SD0004	2.5 SW for 3.5mm Hex Screw Silicon Handle Screw Driver	1
6	DG0001	Depth Gauge 0-50mm	1
7	LDS0004	Ø2.4/2.7mm LHS Drill Sleeve - 50.0mm	2
8	LDS0005	Ø3.5mm LHS Drill Sleeve Short - 60.0mm	2
9	GW0001	Guider Wire (Pointed) Ø1.2mm x 6"	2
10	GW0002	Guider Wire (Pointed) Ø1.5mm x 6"	2
11	BTQ0005	Ø3.5mm Cortex Bone Tap Quick Coupling	1
12	QCS0001	T8 QC Shaft	2
13	QCS0004	2.5 SW for 3.5mm Hex Screw Shaft	2
14	DBQ0006	Drill Bit Ø2.0 x 6" Quick Coupling	2
15	DBQ0007	Drill Bit Ø2.5 x 6" Quick Coupling	2
16	DBQ0010	Drill Bit Ø2.8 x 6" Quick Coupling	2
17	TTQ0001	Quick Coupling T- Handle-STD	1
18	BO0004	Ø2.7/3.5mm Graphical Instrument Box Only	1



# Ø3.5mm Instrument Set (All 3.5mm Plating System) - IS0005

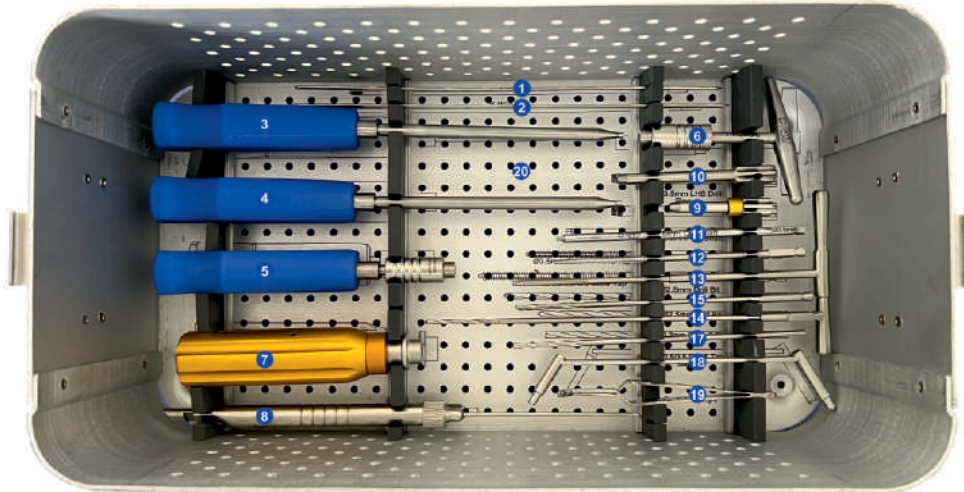
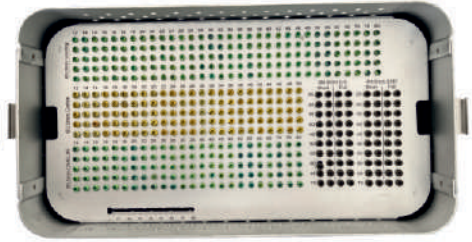
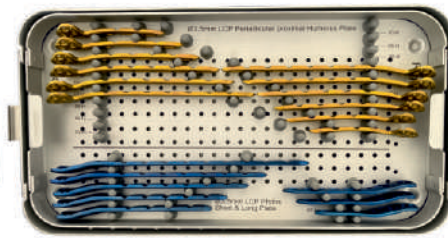
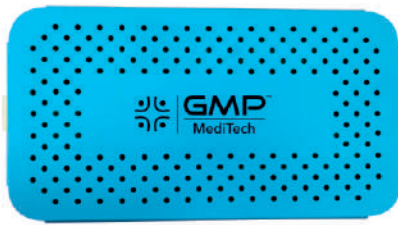

SR.NO.	PRODUCT CODE	PRODUCT NAME	QTY.
1	GW0002	Guider Wire (Pointed) Ø1.5mm x 6"	2
2	GW0005	Guider Wire (Pointed) Ø1.8mm x 6"	2
3	SD0004	2.5 SW for 3.5mm Hex Screw Silicon Handle Screw Driver	1
4	SD0006	4.0mm CC Silicon Handle Screw Drive	1
5	SQH0002	Quick Coupling Silicon Handle-For 2.4/2.7/3.5mm Screw	1
6	TTQ0001	Quick Coupling T- Handle-STD	1
7	TH0005	Torque Limiting Handle 1.5Nm - Alluminium	1
8	DG0003	Depth Gauge 0-100mm	1
9	LDS0005	Ø3.5mm LHS Drill Sleeve Short - 60.0mm	2
10	LDS0006	Ø3.5mm LHS Drill Sleeve Long - 80.0mm	2
11	QCS0004	2.5 SW for 3.5mm Hex Screw Shaft	2
12	BTQ0005	Ø3.5mm Cortex Bone Tap Quick Coupling	1
13	BTT0003	Ø4.0mm Cortex Bone Tap T-Handle	1
14	DBQ0007	Drill Bit Ø2.5 x 6" Quick Coupling	2
15	DBQ0010	Drill Bit Ø2.8 x 6" Quick Coupling	2
16	DBQ0011	Drill Bit Ø2.8 x 8" Quick Coupling	2
17	DBS0018	Drill Bit Ø3.2 x 6" CC Solid	1
18	DEDS006	Double Drill Sleeve 2.5mm/3.5mm	1
19	SF0001	Screw Forcep	1
20	BO0005	Ø3.5/4.0mm Graphical Instrument Box Only	1

# Ø3.5/5.0mm Instrument Set (Proximal Humerus, Tibia, Femur) - IS0006

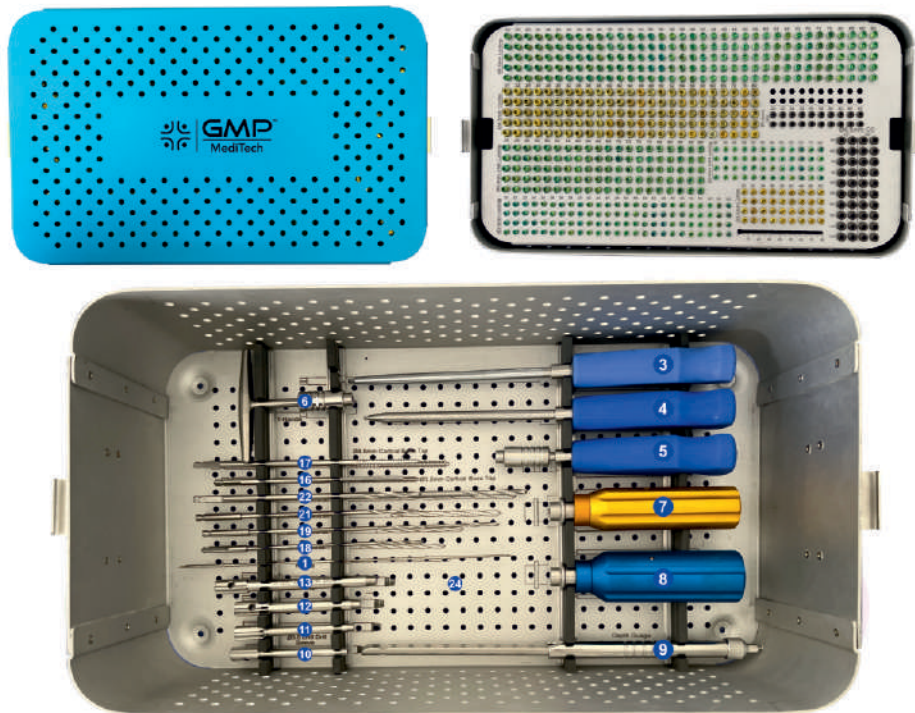

SR.NO.	PRODUCT CODE	PRODUCT NAME	QTY.
1	GW0002	Guider Wire (Pointed) Ø1.5mm x 6"	2
2	GW0005	Guider Wire (Pointed) Ø2.0mm x 6"	2
3	SD0004	2.5 SW for 3.5mm Hex Screw Silicon Handle Screw Driver	1
4	SD0005	3.5 SW for 5.0mm Hex Screw Silicon Handle Screw Driver	1
5	SQH0001	Quick Coupling Silicon Handle-For 4.5/5.0/6.5mm Screw	1
6	TTQ0001	Quick Coupling T- Handle-STD	1
7	TH0005	Torque Limiting Handle 1.5Nm - Alluminium	1
8	TH0006	Torque Limiting Handle 4.0Nm - Alluminium	1
9	DG0003	Depth Gauge 0-100mm	1
10	LDS0005	Ø3.5mm LHS Drill Sleeve Short - 60.0mm	1
11	LDS0006	Ø3.5mm LHS Drill Sleeve Long - 80.0mm	1
12	LDS0007	Ø5.0mm LHS Drill Sleeve Short - 80.0mm	1
13	LDS0008	Ø5.0mm LHS Drill Sleeve Long - 110.0mm	1
14	QCS0004	2.5 SW for 3.5mm Hex Screw Shaft	2
15	QCS0005	3.5 SW for 5.0mm Hex Screw Shaft	2
16	BTQ0005	Ø3.5mm Cortex Bone Tap Quick Coupling	1
17	BTT0002	Ø4.5mm Cortex Bone Tap T-Handle	1
18	DBQ0007	Drill Bit Ø2.5 x 6" Quick Coupling	2
19	DBQ0010	Drill Bit Ø2.8 x 6" Quick Coupling	1
20	DBQ0011	Drill Bit Ø2.8 x 8" Quick Coupling	1
21	DBS0013	Drill Bit Ø3.2 x 6" Solid	2
22	DBS0015	Drill Bit Ø4.3 x 6" Solid	1
23	DBS0016	Drill Bit Ø4.3 x 8" Solid	1
24	BO0006	Ø3.5/5.0mm Graphical Instrument Box Only	1



# Ø5.0mm Instrument Set (All Ø4.5/5.0mm Plating System) - IS0007

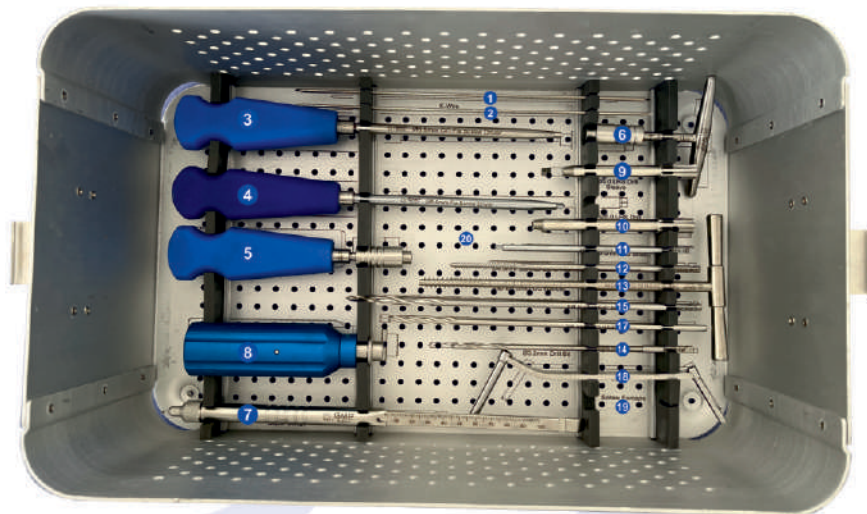
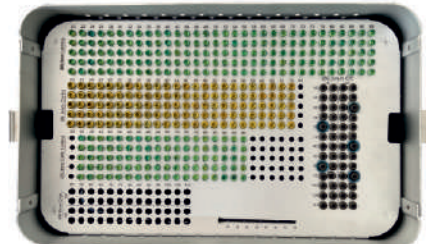
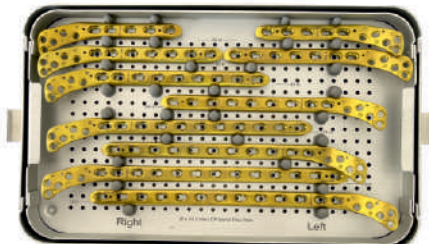
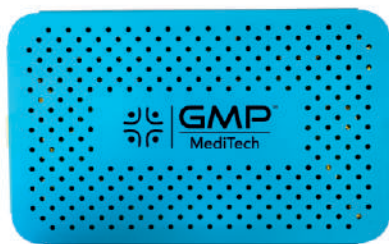

SR.NO.	PRODUCT CODE	PRODUCT NAME	QTY.
1	GW0002	Guider Wire (Pointed) Ø1.5mm x 6"	2
2	GW0005	Guider Wire (Pointed) Ø2.0mm x 6"	2
3	SD0007	6.5mm CC Silicon Handle Screw Drive	1
4	SD0005	3.5 SW for 5.0mm Hex Screw Silicon Handle Screw Driver	1
5	SQH0001	Quick Coupling Silicon Handle-For 4.5/5.0/6.5mm Screw	1
6	TTQ0001	Quick Coupling T- Handle-STD	1
7	TH0006	Torque Limiting Handle 4.0Nm - Alluminium	1
8	DG0003	Depth Gauge 0-100mm	1
9	LDS0007	Ø5.0mm LHS Drill Sleeve Short - 80.0mm	1
10	LDS0008	Ø5.0mm LHS Drill Sleeve Long - 110.0mm	1
11	QCS0005	3.5 SW for 5.0mm Hex Screw Shaft	1
12	BTT0002	Ø4.5mm Cortex Bone Tap T-Handle	1
13	BTT0004	Ø6.5mm Cortex Bone Tap T-Handle	1
14	DBS0013	Drill Bit Ø3.2 x 6" Solid	2
15	DBS0015	Drill Bit Ø4.3 x 6" Solid	1
16	DBS0016	Drill Bit Ø4.3 x 8" Solid	1
17	DBS0020	Drill Bit Ø4.3 x 6" CC Solid	1
18	DEDS008	Double Drill Sleeve 3.2mm/4.5mm	1
19	SF0002	Screw Forcep	1
20	BO0007	Ø5.0/6.5mm Graphical Instrument Box Only	1



**GMP™**

MediTech

*Innovation for life...*



# INTERLOCKING NAIL

A full Range of Product  
for **NAIL**





## PFNA-II Interlocking Nail



**Product Code :** GMP121

**Material :**

SS316L / Titanium / SS316LVM

**Diameter (Short & Long) :**

∅9.0, ∅10.0, ∅11.0, ∅12.0mm

**Length :**

Short Nail - 180.0mm & 240.0mm

Long Nail - 340.0mm To 440.0mm

(Diff. - 20.0mm)

**Direction :**

Short Nail - Universal

Long Nail - Right / Left

## PFNA-II Blade



**Product Code :** GMP141

**Material :**

SS316L / Titanium / SS316LVM

**Length :**

65.0mm To 115.0mm

(Diff. - 5.0mm)

## PFNA-III Screw



**Product Code :** GMP142

**Material :**

SS316L / Titanium / SS316LVM

**Length :**

65.0mm To 115.0mm

(Diff. - 5.0mm)

## ∅4.9mm Interlocking Bolt



**Product Code :** GMP249

**Material :**

SS316L / Titanium / SS316LVM

**Length :**

24.0mm To 60.0mm (Diff. - 2.0mm)

65.0mm To 80.0mm (Diff. - 5.0mm)

## PFNA-II End Cap



**Product Code :** GMP143

**Material :**

SS316L / Titanium

/ SS316LVM

## PFNA-III Inner Screw



**Product Code :** GMP144

**Material :**

SS316L / Titanium

/ SS316LVM

## PFNA-II Instrument Set -NIS003

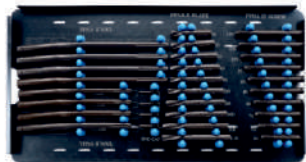
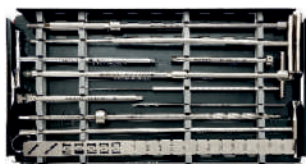
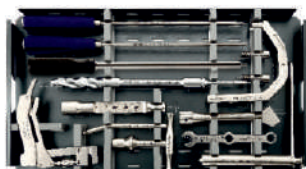

Sr No	Product Code	Description	Qty
1	1100-01	PFNA-II Insertion Jig	1
2	1100-02	Aiming Arm 130° For PFNA-II Blade	1
3	1100-03	PFNA-II Aiming Arm For Dynamic locking	1
4	1100-04	PFNA-II Aiming Arm For Static locking	1
5	1100-05	Conical Bolt For PFNA-II	1
6	1100-06	Adjustable Reamer (16.0mm)	1
7	1100-07	Depth Gauge	1
8	1100-08	Direct Measuring Device For Guide Wire	1
9	1100-09	Protection Locking Sleeve With Compression Unit	1
10	1100-10	Locking Drill Sleeve	1
11	1100-11	Locking Trocar Point	1
12	1100-12	PFNA-II Protection Sleeve (16.0mm)	1
13	1100-13	Guide Wire Sleeve (16.0mm)	1
14	1100-14	PFNA-II Proximal Reamer (16.0mm)	1
15	1100-15	PFNA-II Blade Screw Driver	1
16	1100-16	Cannulated Awl	1
17	1100-17	Crosslink Hammering Device	1
18	1100-18	∅4.5mm Hex Screw Driver	1
19	1100-19	Screw Driver End Cap	1
20	1100-20	Extractor Rod	1
21	1100-21	∅11.0mm Protection Sleeve	1
22	1100-22	∅4.0mm Drill Sleeve	1
23	1100-23	∅4.0mm Trocar Sleeve	1
24	1100-24	Extractor Rod for Blade	1
25	1100-25	Combination Wrench & Key For Blade	1
26	1100-26	Radiographic Scale	1
27	1100-27	Universal Hammer	1
28	1100-28	Quick Coupling Handle	1
29	1100-29	Spherical Head Spanner	1
30	1100-30	Tomy Bar	1
31	1100-31	Stainless Steel Drill Bit ∅4.0mm x 250mm	1
32	1100-32	Nail Removal Guide Wire	1
33	1100-33	Blade Introducer Extractor Rod	1
34	1100-34	Cleaning Guide Wire	1
35	1100-35	Alluminium Graphical Box	1



## Proximal Femur Nail - 130



**Product Code :** GMP122

**Material :**

SS316L / Titanium / SS316LVM

**Diameter (Short & Long) :**

Ø9.0, Ø10.0, Ø11.0, Ø12.0mm

**Length :**

Short Nail - 180.0mm & 250.0mm

Long Nail - 340.0mm To 440.0mm  
(Diff. - 20.0mm)

**Direction :**

Short Nail - Universal

Long Nail - Right / Left

## Proximal Femur Nail - 135



**Product Code :** GMP123

**Material :**

SS316L / Titanium / SS316LVM

**Diameter (Short & Long) :**

Ø9.0, Ø10.0, Ø11.0, Ø12.0mm

**Length :**

Short Nail - 180.0mm & 250.0mm

Long Nail - 340.0mm To 440.0mm  
(Diff. - 20.0mm)

**Direction :**

Short Nail - Universal

Long Nail - Right / Left

## Ø4.9mm Interlocking Bolt



**Product Code :** GMP249

**Material :**

SS316L / Titanium / SS316LVM

**Length :**

24.0mm To 60.0mm (Diff. - 2.0mm)

65.0mm To 80.0mm (Diff. - 5.0mm)

## Ø6.4mm Proximal Bolt



**Product Code :** GMP250

**Material :**

SS316L / Titanium / SS316LVM

**Length :**

55.0mm To 115.0mm

(Diff. - 5.0mm)

## Ø8.0mm Proximal Bolt



**Product Code :** GMP251

**Material :**

SS316L / Titanium / SS316LVM

**Length :**

55.0mm To 115.0mm

(Diff. - 5.0mm)

## PFN End Cap



**Product Code :** GMP145

**Material :**

SS316L / Titanium  
/ SS316LVM

## Proximal Femur Nail Instrument Set - NIS002



Sr No	Product Code	Description	Qty
1	1200-01	PFN/TFN Jig - 135°	1
2	1200-02	PFN/TFN Jig - 130°	1
3	1200-03	Conical Bolt	2
4	1200-04	Ø12.0mm Protection Guide Sleeve	1
5	1200-05	Ø5.5mm Drill Sleeve	1
6	1200-06	Ø8.0mm Protection Guide Sleeve	1
7	1200-07	Ø4.0mm Long Drill Sleeve	1
8	1200-08	Ø2.0mm Guide Wire Sleeve	1
9	1200-09	Ø15.0mm Solapur Sleeve	1
10	1200-10	Ø5.5mm x 300mm Solid SS Drill Bit	1
11	1200-11	Ø4.0mm x 250mm SS Drill Bit	1
12	1200-12	Starting Awl	1
13	1200-13	Ø15.0mm Cannulated Centering Awl	1
14	1200-14	Ø8.0mm Cannulated Reamer for PFN Bolt	1
15	1200-15	Ø6.4mm Cannulated Reamer for Proximal Bolt	1
16	1200-16	Ø6.4mm Cannulated Hex Screw Driver	1
17	1200-17	T-Handle	1
18	1200-18	Awl For Proximal Bolt	1
19	1200-19	Ø4.5mm Hex Screw Driver	1
20	1200-20	Ø10.0mm Socket Wrench	1
21	1200-21	Supin Driver	1
22	1200-22	Depth Gauge	1
23	1200-23	Extractor Rod	1
24	1200-24	Handle For Extractor	1
25	1200-25	Round Hammer	1
26	1200-26	Torny Bar	1
27	1200-27	Ø2.5mm x 1000mm Guide Wire	1
28	1200-28	Ø2.0mm x 400mm Guide Pin	4
29	1200-29	Hammering Attachment With Cap	1
30	1200-30	Tissue Protector	1
31	1200-31	Alluminium Graphical Box	1

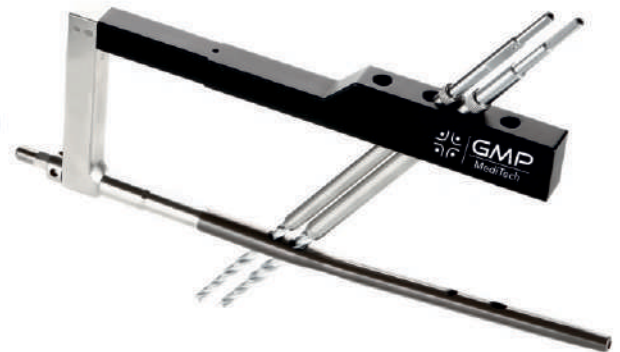



## Expert Tibia Nail



**Product Code :** GMP128  
**Material :**  
 SS316L / Titanium / SS316LVM  
**Diameter :**  
 Ø8.0, Ø9.0, Ø10.0, Ø11.0mm  
**Length :**  
 280.0mm To 380.0mm  
 (Diff. - 20.0mm)

## Ø4.9mm Interlocking Bolt



**Product Code :** GMP249  
**Material :**  
 SS316L / Titanium / SS316LVM  
**Length :**  
 24.0mm To 60.0mm (Diff. - 2.0mm)  
 65.0mm To 80.0mm (Diff. - 5.0mm)

## Expert Tibia Nail End Cap



**Product Code :** GMP146  
**Material :**  
 SS316L / Titanium / SS316LVM

## Ø3.9mm Interlocking Bolt



**Product Code :** GMP248  
**Material :**  
 SS316L / Titanium / SS316LVM  
**Length :**  
 24.0mm To 50.0mm (Diff. - 2.0mm)

## Expert Tibia Nail Instrument Set - NIS004

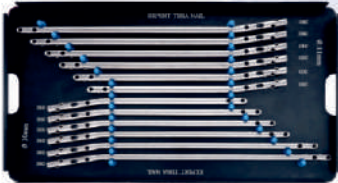

Sr No	Product Code	Description	Qty
1	1300-01	Proximal Jig	1
2	1300-02	Conical Bolt	2
3	1300-03	Ø10.0mm Protection Guide Sleeve	1
4	1300-04	Ø4.0mm Long Drill Sleeve	1
5	1300-05	Awl For Proximal Bolt	1
6	1300-06	Curved Bone Awl	1
7	1300-07	Ø4.0mm x 250mm SS Drill Bit	1
8	1300-08	Ø4.5mm Hex Screw Driver	1
9	1300-09	Ø10.0mm Spanner	1
10	1300-10	Supin Driver	1
11	1300-11	Depth Gauge	1
12	1300-12	Extractor Rod	1
13	1300-13	Handle For Extractor	1
14	1300-14	Round Hammer	1
15	1300-15	Tomy Bar	1
16	1300-16	Ø2.5mm x 1000mm Guide Wire	1
17	1300-17	Tissue Protector	1
18	1300-18	Alluminium Graphical Box	1



## Expert Femur Nail



**Product Code :** GMP129

**Material :**

SS316L / Titanium / SS316LVM

**Diameter :**

Ø9.0, Ø10.0, Ø11.0mm

**Length :**

340.0mm To 440.0mm  
(Diff. - 20.0mm)

**Direction :**

Right / Left

## Ø4.9mm Interlocking Bolt



**Product Code :** GMP249

**Material :**

SS316L / Titanium / SS316LVM

**Length :**

24.0mm To 60.0mm (Diff. - 2.0mm)

65.0mm To 80.0mm (Diff. - 5.0mm)

## Ø6.4mm Proximal Bolt



**Product Code :** GMP250

**Material :**

SS316L / Titanium / SS316LVM

**Length :**

55.0mm To 115.0mm

(Diff. - 5.0mm)

## Expert Femur Nail Instrument Set - NIS006

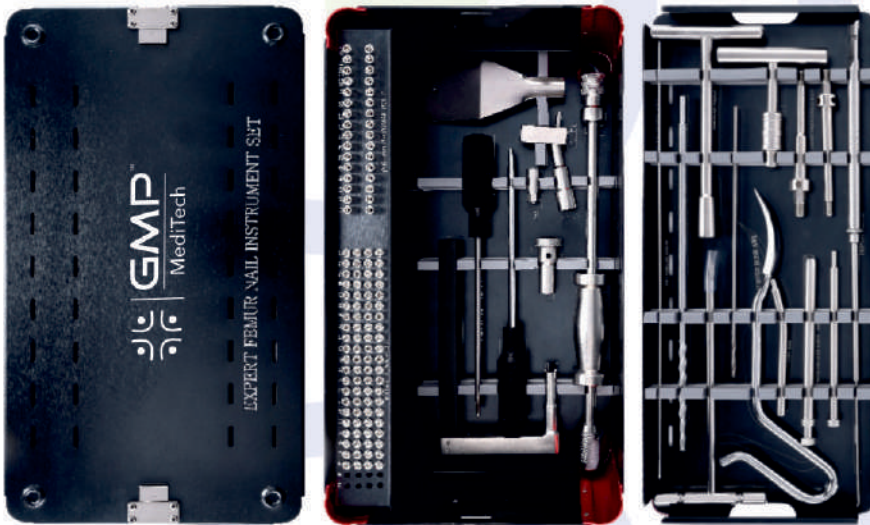

Sr No	Product Code	Description	Qty
1	1800-01	Proximal Jig	1
2	1800-02	Conical Bolt	2
3	1800-03	Ø8.0mm Protection Guide Sleeve	1
4	1800-04	Ø8.0mm Protection Sleeve	1
5	1800-05	Ø8.0mm Guide Wire Sleeve	1
6	1800-06	Ø4.0mm Long Drill Sleeve	1
7	1800-07	Awl For Proximal Bolt	1
8	1800-08	Curved Bone Awl	1
9	1800-09	Ø6.4mm Cannulated Step Drill	1
10	1800-10	Ø6.4mm Cannulated Hex Screw Driver	1
11	1800-11	T-Handle	1
12	1800-12	Ø4.5mm Hex Screw Driver	1
13	1800-13	Ø10.0mm Socket Wrench	1
14	1800-14	Supin Driver	1
15	1800-15	Depth Gauge	1
16	1800-16	Extractor Rod	1
17	1800-17	Handle For Extractor	1
18	1800-18	Round Hammer	1
19	1800-19	Tomy Bar	1
20	1800-20	Hammering Attache With Cap	1
21	1800-21	Ø2.5mm x 1000mm Guide Wire	1
22	1800-22	Tissue Protector	1
23	1800-23	Aluminium Graphical Box	1





## Tibia Nail



**Product Code :** GMP130  
**Material :**  
 SS316L / Titanium / SS316LVM  
**Diameter (Short & Long) :**  
 Ø8.0, Ø9.0, Ø10.0, Ø11.0mm  
**Length :**  
 280.0mm To 380.0mm  
 (Diff. - 20.0mm)

## Femur Nail



**Product Code :** GMP131  
**Material :**  
 SS316L / Titanium / SS316LVM  
**Diameter (Short & Long) :**  
 Ø9.0, Ø10.0, Ø11.0, Ø12.0mm  
**Length :**  
 340.0mm & 440.0mm  
 (Diff. - 20.0mm)

## Ø4.9mm Interlocking Bolt



**Product Code :** GMP249  
**Material :**  
 SS316L / Titanium / SS316LVM  
**Length :**  
 24.0mm To 60.0mm  
 (Diff. - 2.0mm)  
 65.0mm To 80.0mm  
 (Diff. - 5.0mm)

## Ø3.9mm Interlocking Bolt



**Product Code :** GMP248  
**Material :**  
 SS316L / Titanium / SS316LVM  
**Length :**  
 24.0mm To 50.0mm  
 (Diff. - 2.0mm)

## Tibia End Cap



**Product Code :** GMP147  
**Material :**  
 SS316L / Titanium / SS316LVM

## Femur End Cap



**Product Code :** GMP148  
**Material :**  
 SS316L / Titanium / SS316LVM

## I.L Tibia / Femur Nail Instrument Set - NIS001

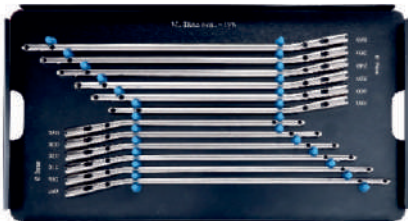
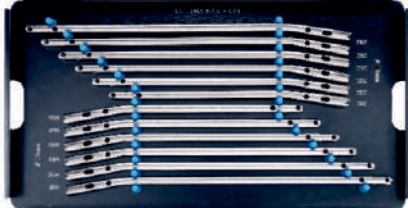
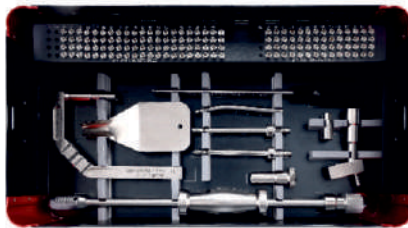

Sr No	Product Code	Description	Qty
1	1400-01	Proximal Jig for Tibia & Femur	1
2	1400-02	Conical Bolt	2
3	1400-03	Protection Sleeve	1
4	1400-04	Ø3.2mm Drill Sleeve	1
5	1400-05	Ø4.0mm Drill Sleeve	1
6	1400-06	Ø4.0mm x 200mm s.s Drill Bit	1
7	1400-07	Ø3.2mm x 200mm s.s Drill Bit	1
8	1400-08	Pointer Sleeve	1
9	1400-09	Curved Bone Awl	1
10	1400-10	Teflon Tube	1
11	1400-11	Ø4.5mm Hex Screw Driver	1
12	1400-12	Ø10.0mm Socket Wrench	1
13	1400-13	Supin Driver	1
14	1400-14	Depth Gauge	1
15	1400-15	Extractor Rod	1
16	1400-16	Handle For Extractor	1
17	1400-17	Round Hammer	1
18	1400-18	Tomy Bar	1
19	1400-19	Hammering Attachment With Cap	1
20	1400-20	Ø2.5mm x 1000mm Guide Wire	1
21	1400-21	Tissue Protector	1
22	1400-22	Alluminium Graphical Box	1

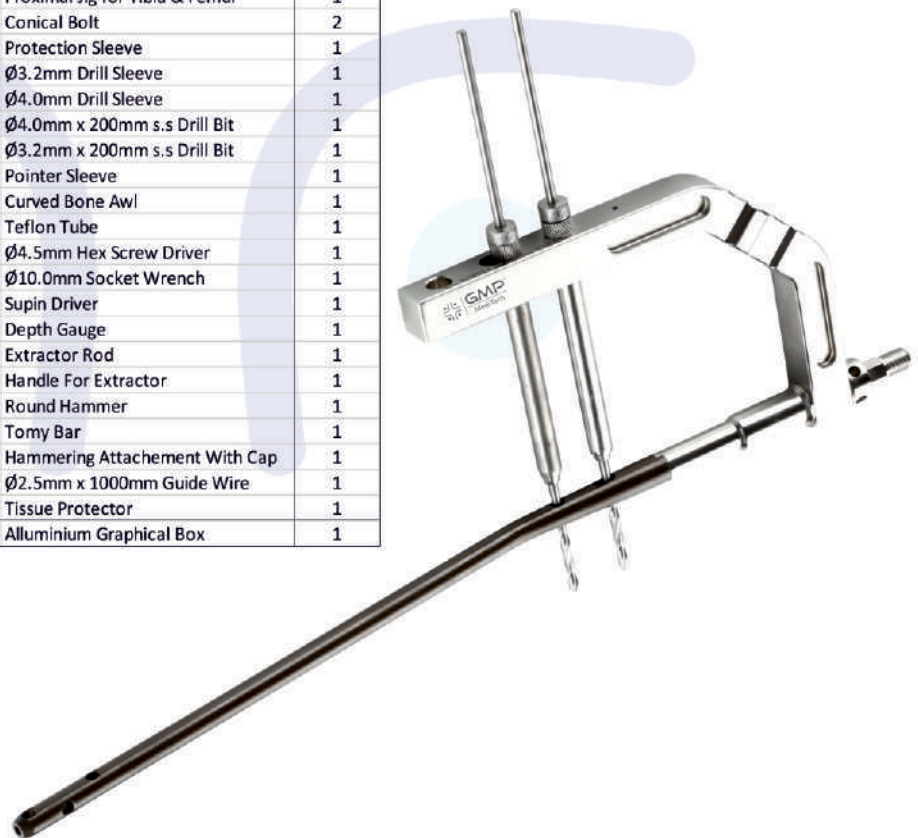

## Humerus Nail



**Product Code :** GMP132  
**Material :**  
 SS316L / Titanium / SS316LVM  
**Diameter :**  
 Ø6.0mm Solid  
 Ø8.0 & Ø9.0mm Cannulated  
**Length :**  
 180.0mm To 300.0mm  
 (Diff. - 20.0mm)

## Ø2.9mm Interlocking Bolt



**Product Code :** GMP246  
**Material :**  
 SS316L / Titanium / SS316LVM  
**Length :**  
 16.0mm To 40.0mm (Diff. - 2.0mm)

## Humerus Nail End Cap



**Product Code :** GMP149  
**Material :**  
 SS316L / Titanium / SS316LVM

## Ø3.4mm Interlocking Bolt



**Product Code :** GMP247  
**Material :**  
 SS316L / Titanium / SS316LVM  
**Length :**  
 16.0mm To 40.0mm (Diff. - 2.0mm)

## Humerus Nail Instrument Set - NIS007

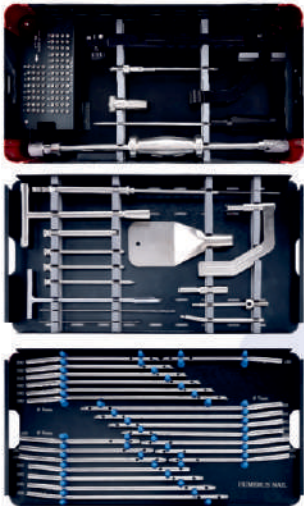

Sr No	Product Code	Description	Qty
1	1500-01	Proximal Jig for UHN	1
2	1500-02	Conical Bolt	2
3	1500-03	Ø8.0mm Protection Guide Sleeve	1
4	1500-04	Ø2.7mm Drill Sleeve	1
5	1500-05	Trocar Sleeve	1
6	1500-06	Straight Awl	1
7	1500-07	Ø2.7mm x 200mm s.s Drill Bit	1
8	1500-08	Compression Sleeve	1
9	1500-09	Compression Attachment with Conical Bolt	1
10	1500-10	Ø4.5mm Hex Screw Driver	1
11	1500-11	Ø10.0mm Spanner	1
12	1500-12	Supin Driver	1
13	1500-13	Depth Gauge	1
14	1500-14	Extractor Rod	1
15	1500-15	Handle For Extractor	1
16	1500-16	Round Hammer	1
17	1500-17	Tomy Bar	1
18	1500-18	Ø1.8mm Guide Wire	1
19	1500-19	Tissue Protector	1
20	1500-20	Alluminium Graphical Box	1





## Supra Condylar Nail



**Product Code :** GMP134  
**Material :**  
 SS316L / Titanium / SS316LVM  
**Diameter :**  
 Ø10.0, Ø11.0, 12.0mm  
**Length :**  
 150.0mm To 350.0mm  
 (Diff. - 50.0mm)

## Ø4.9mm Interlocking Bolt



**Product Code :** GMP249  
**Material :**  
 SS316L / Titanium / SS316LVM  
**Length :**  
 24.0mm To 60.0mm (Diff. - 2.0mm)  
 65.0mm To 80.0mm (Diff. - 5.0mm)

## Ø6.5mm IMSC Screw



**Product Code :** GMP252  
**Material :**  
 SS316L / Titanium / SS316LVM  
**Length :**  
 25.0mm To 100.0mm  
 (Diff. - 5.0mm)

## Supra Condylar Nail End Cap



**Product Code :** GMP150  
**Material :**  
 SS316L / Titanium / SS316LVM

## Supra Condylar Nail Instrument Set - NIS008

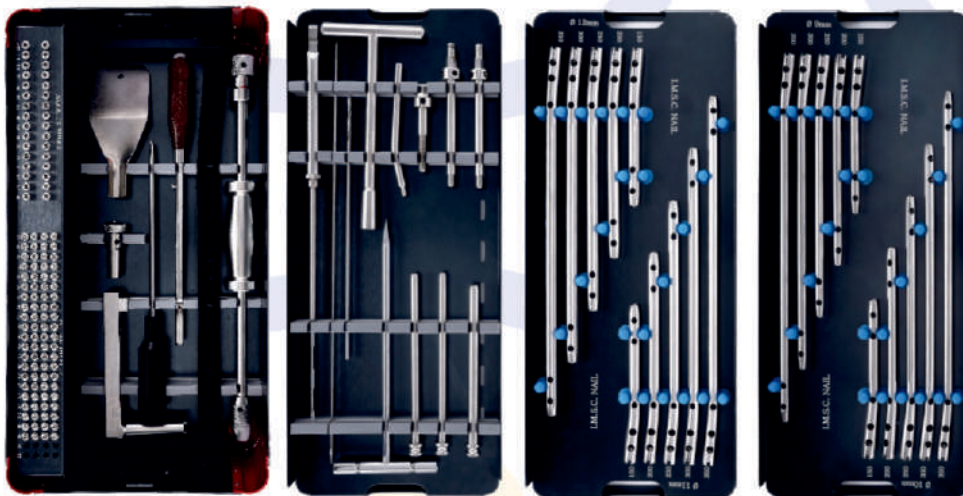

Sr No	Product Code	Description	Qty
1	1600-01	Drill Guide	1
2	1600-02	Guide Bar- up to 350mm	1
3	1600-03	Guide Bolt	1
4	1600-04	Attachment Bolt	1
5	1600-05	Ø8.0mm Guide Sleeve	1
6	1600-06	Ø4.0mm Drill Sleeve	1
7	1600-07	Ø4.0mm Trocar Sleeve	1
8	1600-08	Cannulated Cutter	1
9	1600-09	Direct Measuring Device	1
10	1600-10	Ø4.0mm x 250mm S.S Drill Bit	1
11	1600-11	Ø2.5mm x 300mm Calibrated Guide wire	1
12	1600-12	Ø4.5mm Hex Screw Driver	1
13	1600-13	10.0mm Spanner	1
14	1600-14	Supine Driver	1
15	1600-15	Depth Gauge	1
16	1600-16	Extractor Rod	1
17	1600-17	Handle For Extractor	1
18	1600-18	Round Hammer	1
19	1600-19	Tomy Bar	1
20	1600-20	Ø2.5mm x 1000mm Guide Wire	1
21	1600-21	Tissue Protector	1
22	1600-22	Alluminium Graphical Box	1



## Elastic Nail

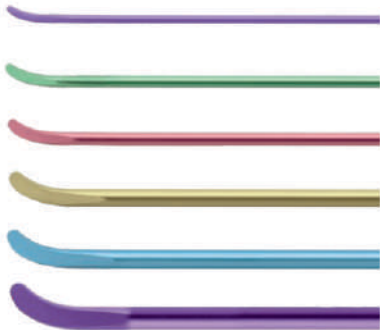

**Product Code :** GMP135

**Material :**

Titanium

**Diameter :**

Ø1.5, Ø2.0, Ø2.5, Ø3.0,  
Ø3.5, Ø4.0, Ø4.5mm

**Length :**

440.0mm

## Elastic Nail Instrument Set - NIS009

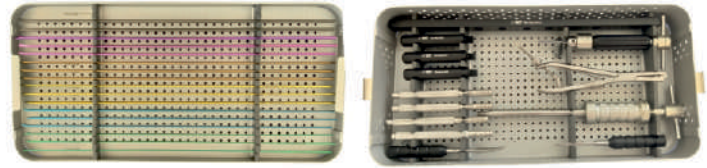

Sr No	Product Code	Description	Qty
1	1700-01	Bending Device	1
2	1700-02	Chuck with T- Handle	1
3	1700-03	Remover Player	1
4	1700-04	Round Hammer with T-Handle	1
5	1700-05	Stright Bone AWL	1
6	1700-06	Curved Bone Awl	1
7	1700-07	Main Punch	1
8	1700-08	Ø2.0/2.5mm Sleeve	1
9	1700-09	Ø3.0/3.5mm Sleeve	1
10	1700-10	Ø4.0/4.5mm Sleeve	1
11	1700-11	Bending Rod	1
12	1700-12	Alluminium Graphical Box	1

## Rush Nail

**Product Code :** GMP136

**Material :**

SS316L

**Diameter :**

Ø2.0, Ø2.5, Ø3.0, Ø3.5,  
Ø4.0, Ø4.5, 5.0mm

**Length :**

200.0mm To 300.0mm  
(Diff.- 10.0mm)



## Square Nail For Ulna

**Product Code :** GMP137

**Material :**

SS316L

**Diameter :**

Ø2.0, Ø2.5, Ø3.0, Ø3.5mm

**Length :**

200.0mm To 300.0mm  
(Diff.- 10.0mm)



## Square Nail For Radius

**Product Code :** GMP138

**Material :**

SS316L

**Diameter :**

Ø2.0, Ø2.5, Ø3.0, Ø3.5mm

**Length :**

200.0mm To 300.0mm  
(Diff.- 10.0mm)



## Enders Nail

**Product Code :** GMP139

**Material :**

SS316L

**Diameter :**

Ø3.0, Ø3.5, Ø4.0, Ø4.5mm

**Length :**

140.0mm To 300.0mm  
(Diff.- 20.0mm)



## Screw Nail

**Product Code :** GMP140

**Material :**

Titanium

**Diameter :**

Ø2.0, Ø2.5, Ø3.0, Ø3.5mm

**Length :**

180.0mm To 300.0mm  
(Diff.- 20.0mm)





# CERTIFICATES

**FORM MD-5**  
[See sub-rule (4) of rule 20 and sub-rule (5) of rule 20]

Government of India  
Directorate General of Health Services  
Central Drugs Standard Control Organisation  
Ministry of Health and Family Welfare

**License to Manufacture for Sale or for Distribution of Class A or Class B medical device**

License Number: MF/GMD/2022/00065

1. M/s GMP MEDITECH, D-3, Center Point Industrial Park, Gandhinagar-Visnagar Highway, Village- Kadar/Visnagar, Mehsana, Gujarat (India) - 384305 Telephone No.: 9512501131 FAX: 9512501131 has been licensed to manufacture for sale or for distribution (the below listed medical devices) at the premises situated at M/s GMP Meditech, D-3, Center Point Industrial Park, Gandhinagar-Visnagar Highway, Village-Kada, Tal-Visnagar, Mehsana, Gujarat (India) - 384305 Telephone No.: 9512501131 FAX: 9512501131

2. Details of medical devices (Annexed)

3. This license is subject to the provisions of the Medical Devices Rules, 2017 and conditions prescribed therein.

**ANNEXURE**  
Details Of Device(s)

1. **Generic Name:** Spinal Cage and Cervical Disk System Instruments  
**Model No.:** Cage Fixator Storage - Cage Washer Carrier, Cage Heater, Lock Screw Driver, Cage Cutter, Retainer Straight, Retainer Curved, Retainer PIV (Rotary) Cage Instruments, Chisel 7.0mm - Chisel 8.0mm, Chisel 9.0mm, Chisel 10.0mm, Chisel 11.0mm, Disc Chisel T.I. mm, Box Chisel 8.0mm, Box Chisel 10.0mm, Box Chisel 12.0 mm/Box, Chisel 11.0mm, Threaded Box Carrier - Left Box Carrier, Right Box Carrier, Left Cog Curvicle, Right Cog Curvicle, rasp, graft seal holder, disc spacer, bone tampster mass system  
**Intended Use:** The spinal cage and cervical disk system instruments are used to support for spinal implants, discors or hardware, using surgical procedures to implant titanium, titanium alloy, stainless steel or non-metallic devices into the spine.  
**Class of medical device:** Class A  
**Material of construction:** STAINLESS STEEL, ALUMINIUM, DELRIN, PEEK, PEEK, SILICON, CARBON FIBER  
**Dimensional (s) / Various Dimensions:** SPECIFICALLY  
**Sterile or Non sterile:** Non-Sterilized  
**Brand Name(s):** registered under the Trade Marks Act, 1999/GMP MEDITECH

2. Details of manufacturer:  
 D-3, Center Point Industrial Park, Gandhinagar, Visnagar Highway, Village - Kada, Tal: Visnagar, Dist: Mehsana - 384305, Gujarat, India  
 Tel: 9512501131  
 Fax: 9512501131  
 Email: info@gmpmeditech.com  
 Date: 2022/07/26  
 143857-4297

**FORM MD-5**  
[See sub-rule (4) of rule 20 and sub-rule (5) of rule 20]

Government of India  
Directorate General of Health Services  
Central Drugs Standard Control Organisation  
Ministry of Health and Family Welfare

**License to Manufacture for Sale or for Distribution of Class C or Class D medical device**

License Number: MF/GMD/2022/00062

1. M/s GMP MEDITECH, D-3, Center Point Industrial Park, Gandhinagar-Visnagar Highway, Village- Kadar/Visnagar, Mehsana, Gujarat (India) - 384305 Telephone No.: 9512501131 FAX: 9512501131 has been licensed to manufacture for sale or for distribution (the below listed medical devices) at the premises situated at M/s GMP Meditech, D-3, Center Point Industrial Park, Gandhinagar-Visnagar Highway, Village-Kada, Tal-Visnagar, Mehsana, Gujarat (India) - 384305 Telephone No.: 9512501131 FAX: 9512501131

2. Details of medical devices (Annexed)

3. The name, qualifications and experience of the competent technical staff responsible for the manufacture and testing of the above mentioned medical device(s) is per records maintain by the manufacturer

4. This license is subject to the provisions of the Medical Devices Rules, 2017 and conditions prescribed therein.

**ANNEXURE**  
Details Of Device(s)

1. **Generic Name:** Spinal Cage and Cervical Disk System Instruments  
**Model No.:** Cage Fixator Storage - Cage Washer Carrier, Cage Heater, Lock Screw Driver, Cage Cutter, Retainer Straight, Retainer Curved, Retainer PIV (Rotary) Cage Instruments, Chisel 7.0mm - Chisel 8.0mm, Chisel 9.0mm, Chisel 10.0mm, Chisel 11.0mm, Disc Chisel T.I. mm, Box Chisel 8.0mm, Box Chisel 10.0mm, Box Chisel 12.0 mm/Box, Chisel 11.0mm, Threaded Box Carrier - Left Box Carrier, Right Box Carrier, Left Cog Curvicle, Right Cog Curvicle, rasp, graft seal holder, disc spacer, bone tampster mass system  
**Intended Use:** The spinal cage and cervical disk system instruments are used to support for spinal implants, discors or hardware, using surgical procedures to implant titanium, titanium alloy, stainless steel or non-metallic devices into the spine.  
**Class of medical device:** Class A  
**Material of construction:** STAINLESS STEEL, ALUMINIUM, DELRIN, PEEK, PEEK, SILICON, CARBON FIBER  
**Dimensional (s) / Various Dimensions:** SPECIFICALLY  
**Sterile or Non sterile:** Non-Sterilized  
**Brand Name(s):** registered under the Trade Marks Act, 1999/GMP MEDITECH

2. Details of manufacturer:  
 D-3, Center Point Industrial Park, Gandhinagar, Visnagar Highway, Village - Kada, Tal: Visnagar, Dist: Mehsana - 384305, Gujarat, India  
 Tel: 9512501131  
 Fax: 9512501131  
 Email: info@gmpmeditech.com  
 Date: 2022/07/26  
 143857-4297

**FORM MD-5**  
[See sub-rule (4) of rule 20 and sub-rule (5) of rule 20]

Government of India  
Directorate General of Health Services  
Central Drugs Standard Control Organisation  
Ministry of Health and Family Welfare

**License to Manufacture for Sale or for Distribution of Class C or Class D medical device**

License Number: MF/GMD/2022/00062

1. M/s GMP MEDITECH, D-3, Center Point Industrial Park, Gandhinagar-Visnagar Highway, Village- Kadar/Visnagar, Mehsana, Gujarat (India) - 384305 Telephone No.: 9512501131 FAX: 9512501131 has been licensed to manufacture for sale or for distribution (the below listed medical devices) at the premises situated at M/s GMP Meditech, D-3, Center Point Industrial Park, Gandhinagar-Visnagar Highway, Village-Kada, Tal-Visnagar, Mehsana, Gujarat (India) - 384305 Telephone No.: 9512501131 FAX: 9512501131

2. Details of medical devices (Annexed)

3. The name, qualifications and experience of the competent technical staff responsible for the manufacture and testing of the above mentioned medical device(s) is per records maintain by the manufacturer

4. This license is subject to the provisions of the Medical Devices Rules, 2017 and conditions prescribed therein.

**ANNEXURE**  
Details Of Device(s)

1. **Generic Name:** Spinal Cage and Cervical Disk System Instruments  
**Model No.:** Cage Fixator Storage - Cage Washer Carrier, Cage Heater, Lock Screw Driver, Cage Cutter, Retainer Straight, Retainer Curved, Retainer PIV (Rotary) Cage Instruments, Chisel 7.0mm - Chisel 8.0mm, Chisel 9.0mm, Chisel 10.0mm, Chisel 11.0mm, Disc Chisel T.I. mm, Box Chisel 8.0mm, Box Chisel 10.0mm, Box Chisel 12.0 mm/Box, Chisel 11.0mm, Threaded Box Carrier - Left Box Carrier, Right Box Carrier, Left Cog Curvicle, Right Cog Curvicle, rasp, graft seal holder, disc spacer, bone tampster mass system  
**Intended Use:** The spinal cage and cervical disk system instruments are used to support for spinal implants, discors or hardware, using surgical procedures to implant titanium, titanium alloy, stainless steel or non-metallic devices into the spine.  
**Class of medical device:** Class A  
**Material of construction:** STAINLESS STEEL, ALUMINIUM, DELRIN, PEEK, PEEK, SILICON, CARBON FIBER  
**Dimensional (s) / Various Dimensions:** SPECIFICALLY  
**Sterile or Non sterile:** Non-Sterilized  
**Brand Name(s):** registered under the Trade Marks Act, 1999/GMP MEDITECH

2. Details of manufacturer:  
 D-3, Center Point Industrial Park, Gandhinagar, Visnagar Highway, Village - Kada, Tal: Visnagar, Dist: Mehsana - 384305, Gujarat, India  
 Tel: 9512501131  
 Fax: 9512501131  
 Email: info@gmpmeditech.com  
 Date: 2022/07/26  
 143857-4297

Product Certification



**Certification of Registration**  
CERTIFICATE OF COMPLIANCE

## GMP MEDITECH

**FACTORY:**  
D-3, Center Point Industrial Park, Gandhinagar - Visnagar Highway, Village - Kada, Tal: Visnagar, Dist: Mehsana - 384305, Gujarat, India

Hereby granted the Certificate Number **EC1441/2022:1122**

This is to certify that the Product Requirements of the above organization and conformity assessment procedure & Test carried out & reviewed against the Council EU Guideline / EAC Code / Standard / Directive 93/42/EEC & 2001/95/EC, as amended, and found to comply against the Scope: Manufacture, Supply, Performance Testing & Export of following:

**MEDICAL / SURGICAL & ORTHOPAEDIC IMPLANTS / INSTRUMENTS COVERED IN CE MARKING:**

**MANUFACTURER** - GMP MEDITECH  
**PRODUCTS** - BONE NAIL, BONE SCREW, BONE PLATE, SPINAL IMPLANTS, MAXILLOFACIAL IMPLANTS, TOTAL HIP REPLACEMENT SYSTEM, PIN & WIRES, EXTERNAL FIXATORS, ARTHROSCOPY, MEDICAL DEVICE / INSTRUMENTS / EQUIPMENTS

The CE Mark shown on the product, under the responsibility of the Manufacturer, demonstrates its conformity with the applicable EU Directives. The appearance of a single registration of one category of device does not imply that the device is exempt from the applicable CE marking requirements. The manufacturer of any device bearing this CE Mark must ensure that the manufacturing conditions of the quality system are always subject to surveillance and compliance according to the CE Marking Rules. Certificate validity is conditioned by positive results of surveillance audits.

Originally Registered: 04 NOV, 2022      Latest Issue: 04 NOV, 2022      Expiry Date: 03 NOV, 2025

**For, EURO CERT**

Chief Executive Officer



ISO 13485 : 2016

Product Certification



**Certification of Registration**  
CERTIFICATE OF COMPLIANCE

## GMP MEDITECH

**FACTORY:**  
D-3, Center Point Industrial Park, Gandhinagar - Visnagar Highway, Village - Kada, Tal: Visnagar, Dist: Mehsana - 384305, Gujarat, India

Hereby granted the Certificate Number **EC1442/2022:1122**

This is to certify that the Quality Management Systems for Medical Devices of above organization have been assessed and registered as per the conformity assessment procedure specified in Council EAC Code / Standard / Directive - 93/42/EEC & 2001/95/EC, on Medical / Surgical Devices, as amended, and found to comply.

**MANUFACTURE, SUPPLY & EXPORT OF PRODUCTS COVERED UNDER ISO 13485: 2016:**

- BONE NAIL, BONE SCREW, BONE PLATE
- SPINAL IMPLANTS
- MAXILLOFACIAL IMPLANTS
- TOTAL HIP REPLACEMENT SYSTEM
- PIN & WIRES
- EXTERNAL FIXATOR
- ARTHROSCOPY
- MEDICAL DEVICE INSTRUMENTS / MEDICAL EQUIPMENTS

The CE Mark shown on the product, under the responsibility of the Manufacturer, demonstrates its conformity with the applicable EU Directives. The appearance of a single registration of one category of device does not imply that the device is exempt from the applicable CE marking requirements. The manufacturer of any device bearing this CE Mark must ensure that the manufacturing conditions of the quality system are always subject to surveillance and compliance according to the CE Marking Rules. Certificate validity is conditioned by positive results of surveillance audits.

Originally Registered: 04 NOV, 2022      Latest Issue: 04 NOV, 2022      Expiry Date: 03 NOV, 2025

**For, EURO CERT**

Chief Executive Officer



ISO 13485 : 2016



📍 Corporate Office : 407, Rudram Icon, Opp. Lambda House, Nr. Silver Oak Engineering College, S. G. Highway, Gota, Ahmedabad, Gujarat - 382481, INDIA.

📍 Mfg. Unit : D-3, Center Point Industrial Park, Gandhinagar-Visnagar Highway, Village- Kada, Visnagar, Gujarat - 384305, INDIA.

☎ +91 95109 53131, +91 95125 93131

✉ info@gmpmeditech.com

🌐 www.gmpmeditech.com

Follow us : 